



FIU
Applied Research
Center

solution driven

FIU PROJECT 1

CHEMICAL PROCESS ALTERNATIVES FOR RADIOACTIVE WASTE

FLORIDA INTERNATIONAL UNIVERSITY

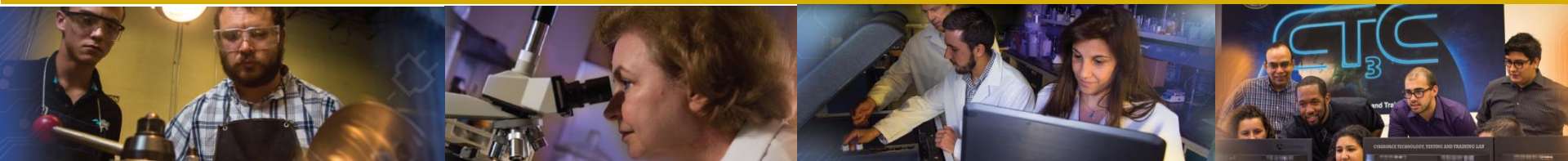



FIU Personnel and Collaborators



Principal Investigator: Leonel Lagos

Project Manager: Dwayne McDaniel

Faculty/Staff: Amer Awwad, Anthony Abrahao, Aparna Aravelli, Reza Abbasi Bahranchi, William Tan, Jose Rivera, Shervin Tashakori, Mayren Boan

DOE Fellows/Students: Christopher Excellent, Patrick Uriarte, Edward Nina, Jeff Natividad, Daniel Martin, Michael Thompson, Michael DiBono, Jason Soto, Anilegna Nunez Abreau

DOE-EM: Gary Peterson, Kurt Gerdes, Genia McKinley

DOE-ORP: Dustin Stewart

WRPS: Dennis Washenfelder, Ruben Mendoza, Jason Gunter, Kayle Boomer, Jason Vitale, Steven Kelly

SRNL: Michael Poirer, Connie Herman, Dave Herman, Ken Imrich, Bruce Wiersma

PNNL: Kayte Denslow, Carl Enderlin, Harold Atkins, Matt Fountain



Project Tasks and Scope



Task 17 Advanced Topics for Mixing Processes

- Investigate formation of sediment beds and pipeline flushing operations via FIU test loop

Task 18 Technology Development and Instrumentation Evaluation

- Development of inspection tools for waste transfer lines and DST primary tanks
- Investigate approaches/coatings to protect the walls in the exhaust channel at H-Canyon (NEW)

Task 19 Pipeline Integrity and Analysis

- Pipeline corrosion and erosion detection
- Nonmetallic materials evaluation

Task 20 Technology Evaluations using DST Mockup

- Evaluate the viability of inspection tools, robotic systems and sensors using FIU's DST sectional mockup.



Task 17 - Advanced Topics for Mixing Processes

17.3 - Evaluation of Pipeline Flushing Requirements for HLW at Hanford and Savannah River



Site Needs:

- According to the Defense Nuclear Facilities Safety Board, a number of issues still exist regarding the slurry transport and flushing strategies at Hanford.
- A series of flushing tests can address a variety of technical gaps associated with flushing techniques and would be beneficial to both Hanford and Savannah River.

Objectives:

- Conduct a series of experimental tests to bridge technical gaps associated with the flushing of HLW within the transfer systems at Hanford and Savannah River.
- Tests will be conducted using the loop that were developed in Year 9.
- The loop can be expanded to multiple of its lengths ranging from 165 ft to 825 ft for scale up analysis (study of length effect on flush operation efficiency).



Supernatant Dried on Nozzle
18 in AP Valve Pit.



Task 17 - Advanced Topics for Mixing Processes

17.3 Evaluation of pipeline flushing requirements for HLW at Hanford and Savannah River



Accomplishments

Background:

- Current guidelines for flushing at sites:
 - TFC-ENG-STD-26, REV C-1 and STD-26 or RPP-RPT-59600 Rev.00
 - **Minimum** flush to line volume (FTLV): 1.5; **Recommended** FTLV: 1.5-3
 - **Minimum** flush velocity (FV): 10 ft/sec; **Recommended** FV: 4 to 6ft/s
 - **Maximum** FV: 10 ft/s (if glass formers present) and 12 ft/s (if no glass formers)
- Previous flushing test results (PNNL-17973.WTP-RPT-178 Rev. 0 and PNNL-17639. WTP-RPT-175 Rev. 0)
 - FV higher than erosion-safe limit
 - Pre-pressurized water rather than pump
 - No data for post flush evaluations
 - FTLV values exceeding 6 was reported

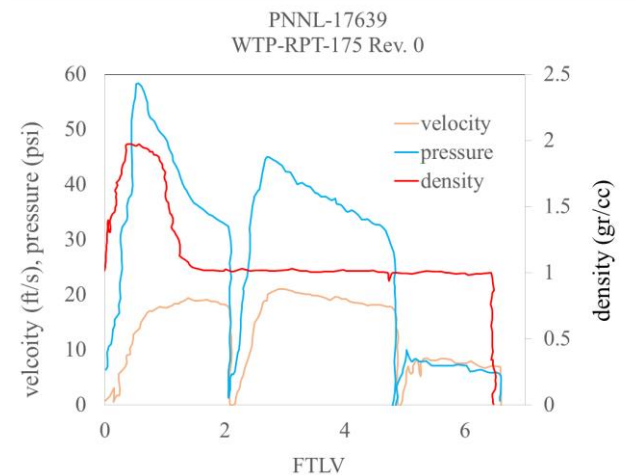



Development of a Testbed for Pipeline Flushing



Loop Design

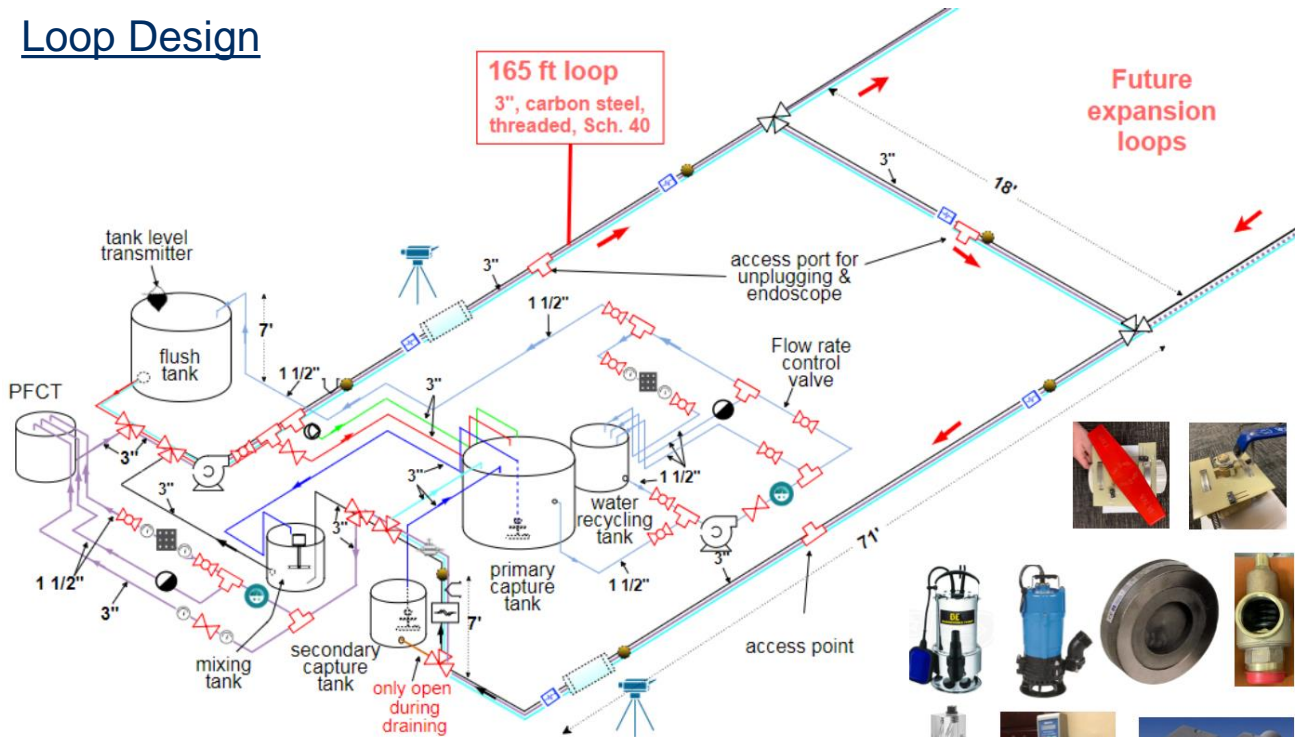

color and symbol codes:

— (black line)	— (dashed line)	⊗ (square with dot)	⊗ (square with dot)
— (red line)	⊗ (circle with dot)	⊗ (circle with dot)	⊗ (circle with dot)
— (dotted line)	⊗ (circle with dot)	⊗ (circle with dot)	⊗ (circle with dot)
— (orange line)	⊗ (circle with dot)	⊗ (circle with dot)	⊗ (circle with dot)
— (green line)	⊗ (circle with dot)	⊗ (circle with dot)	⊗ (circle with dot)
— (blue line)	⊗ (circle with dot)	⊗ (circle with dot)	⊗ (circle with dot)
— (purple line)	⊗ (circle with dot)	⊗ (circle with dot)	⊗ (circle with dot)

— : pre-flush circulation
 — : flushing
 — : cleaning of the slurry pump
 ... : post-flush measurement
 — : drain line
 — : pressure relief line
 — : water recycling
 — : solids recycling
 — : transparent section
 ⊗ : pressure transducer
 ⊗ : thermocouple
 ⊗ : filter
 ⊗ : PulseEcho installation flat
 ⊗ : submersible sump pump
 ⊗ : float pump
 ⊗ : Coriolis meter
 ⊗ : bleed valve
 ⊗ : rotameter
 ⊗ : mixer
 ⊗ : rupture disk
 ⊗ : relief valve
 ⊗ : pressure gauge





Development of a Testbed for Pipeline Flushing



Loop Design and Construction

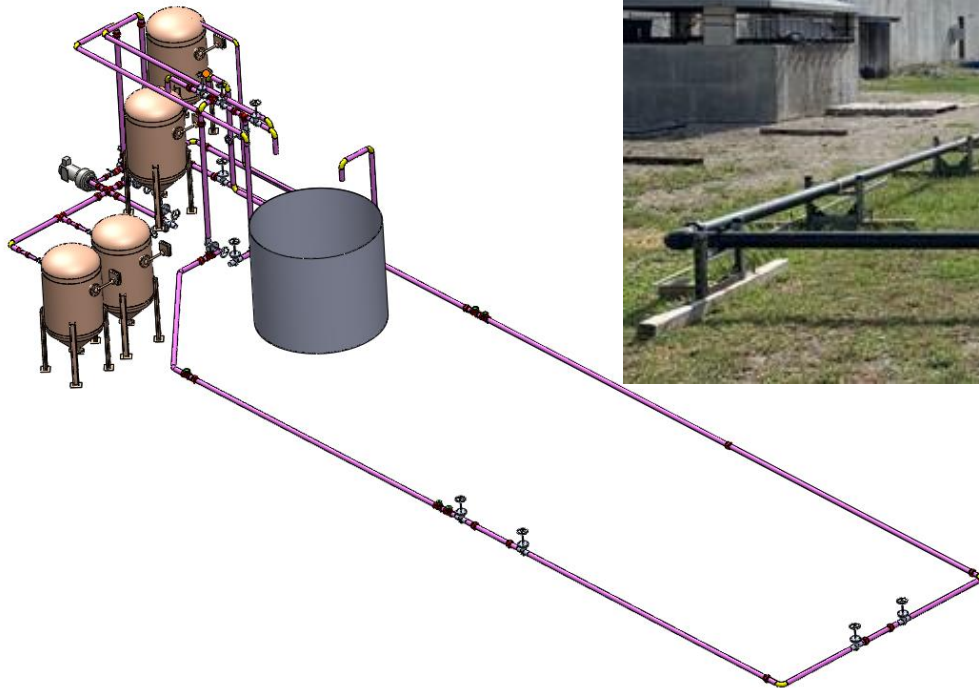



Development of a Testbed for Pipeline Flushing



Loop Construction





Development of a Testbed for Pipeline Flushing



Preliminary Testing

- Leak test all system parts, pump control automation using VFD software

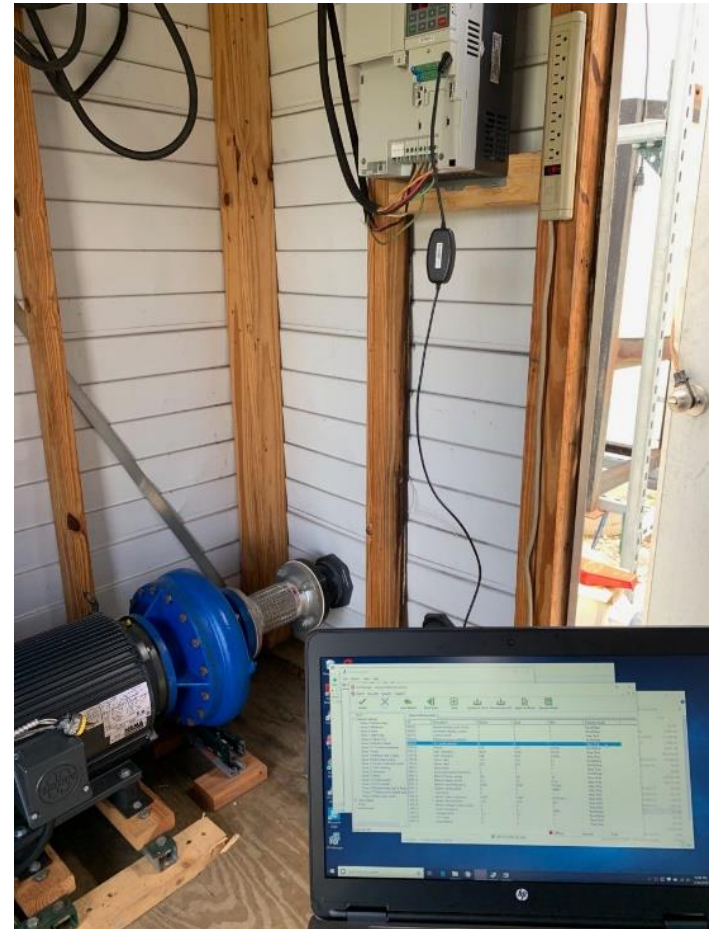



Development of a Testbed for Pipeline Flushing



Preliminary Testing

- Rheology testing (kaolin-water 9-22 vol.%) using new equipment (Haake Viscotester iQ Air)
- Powder characterization

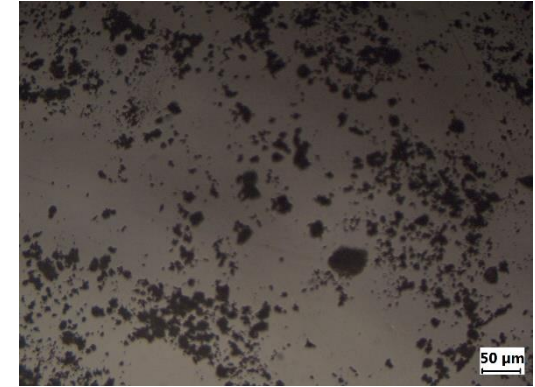
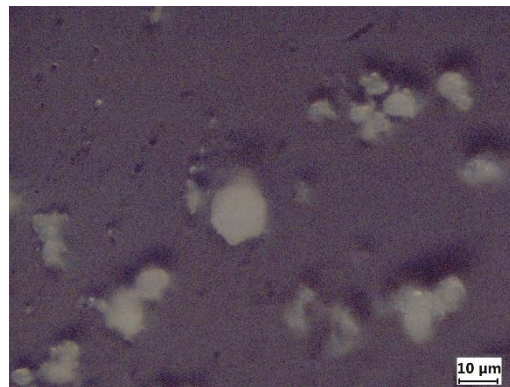
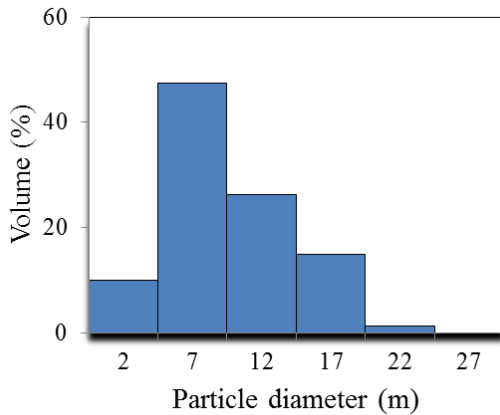

Kaolin powder used in testing



Development of a Testbed for Pipeline Flushing



Preliminary Testing

- Ultrasonic testing for fully developed and drained initial conditions

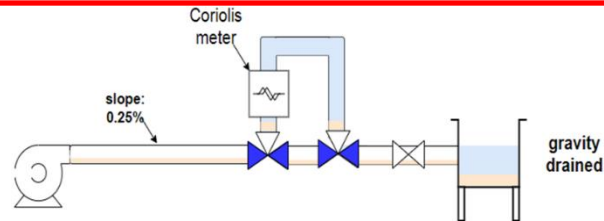
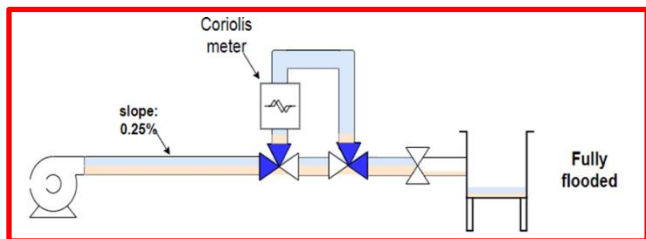

Initial conditions

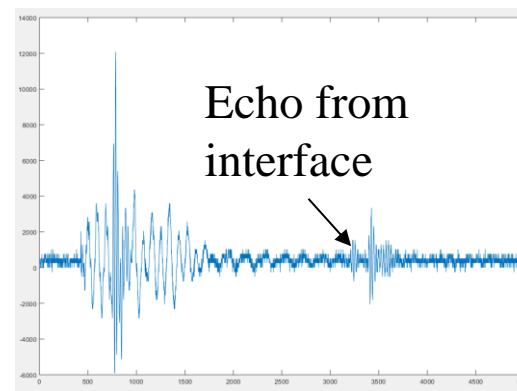
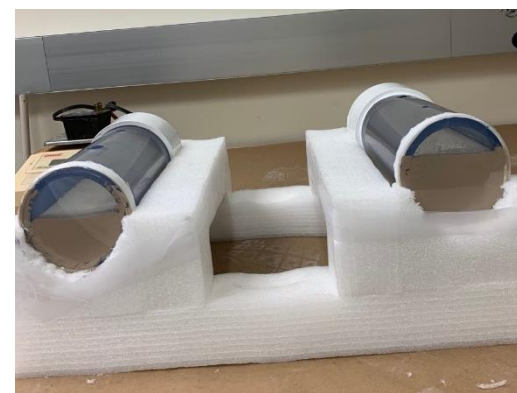
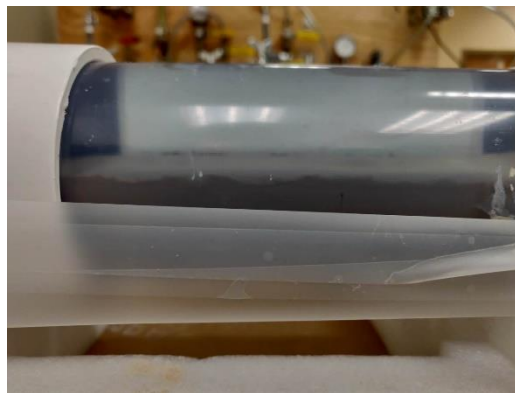

Fully-flooded I.C.



Development of a Testbed for Pipeline Flushing



Preliminary Testing

- Ultrasonic testing for fully developed and drained initial conditions

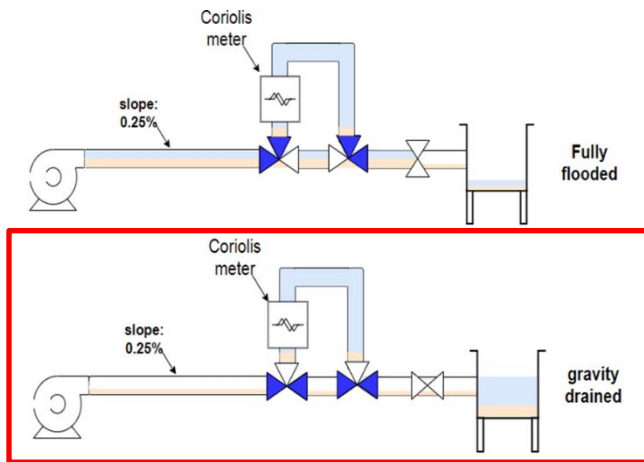

Initial conditions

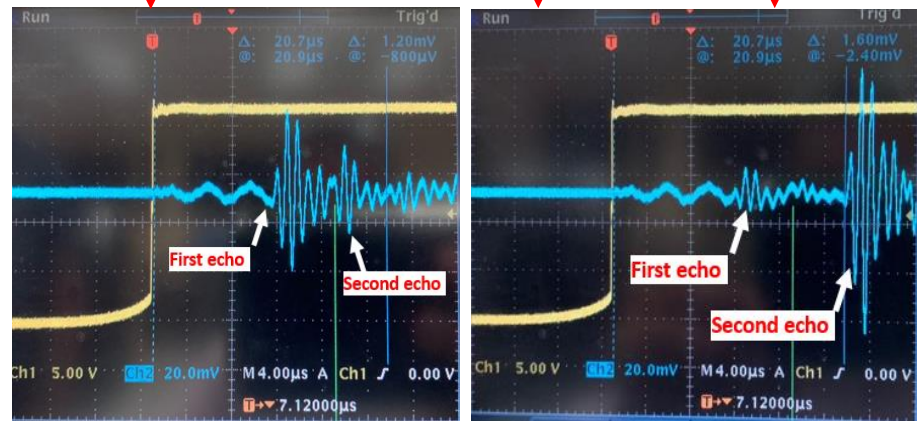

Gravity-drained I.C.



Development of a Testbed for Pipeline Flushing



Current Efforts

CFD of flushing operation

- TFM multiphase, k- ω turbulence, various V_{in} (3 to 10 ft/s), a typical fixed-length pipe line, monitoring of \dot{m}_{solid} at exit, stop at zero \dot{m}_{solid} , and measure/compare the used water volumes.
- A linear correlation between V_{in} and flush-to-line-volume (FTLV) was found ($FTLV_{min}=1.5$ @ 10 ft/s)

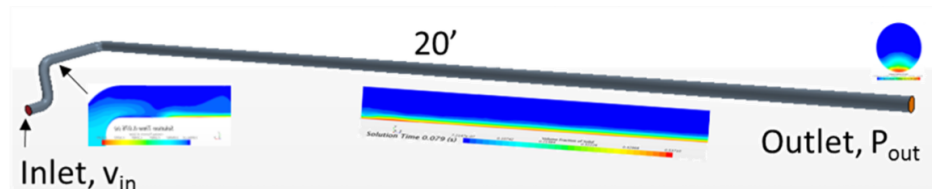
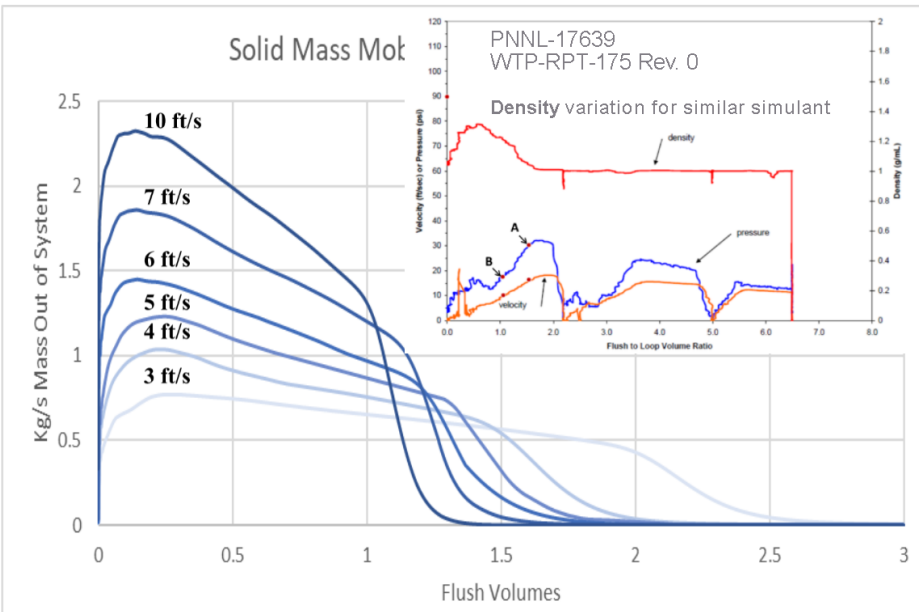

Contour of solid volume fraction

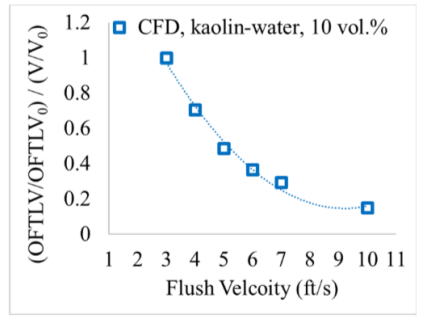
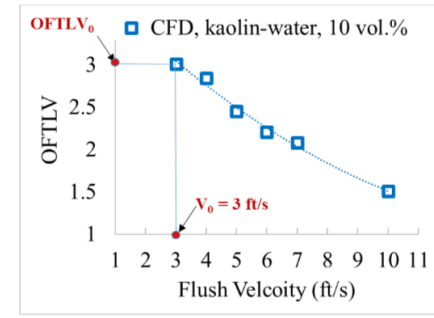

Overall Flush to line volume (OFTLV) vs flush velocity (left), ratio of normalized variables (reference values @ 3 ft/s)



Task 17 - Advanced Topics for Mixing Processes

17.3 Evaluation of pipeline flushing requirements for HLW at Hanford and Savannah River



Proposed Scope for Performance Year 10

- Conduct initial tests on the loop completed in Year 9
 - Removal of air from the system
 - Incorporation of Optimass 1000 Coriolis meter into the loop
 - Accurate density/mass flow rate measurements via the Coriolis meter
- Create repeatable initial conditions (fully-flooded and gravity-drained)
 - Accurate characterization of initial conditions (sediment bed height, solids concentration, and rheology)
- Advance computational investigations that were performed in Year 9 using the Star-CCM+ to full-scale simulations
 - Compliment experimental



Task 18 - Technology Development and Instrumentation Evaluation

18.2 - Development of Inspection Tools for DST Primary Tanks



Site Needs:

In 2012, tank waste was found in the annulus of AY-102. In addition, thinning (up to 70%) of the secondary liner in the annulus region has also been observed in other double shell tanks (DSTs). Understanding of the structural integrity of all DSTs at Hanford is of paramount importance - thus, the significant need for development of tools/sensors that can provide information regarding the health of the tanks.

There are three possible entry points:
 (1) refractory air slots through the annulus,
 (2) 6" leak detection piping,
 (3) 4" air supply piping

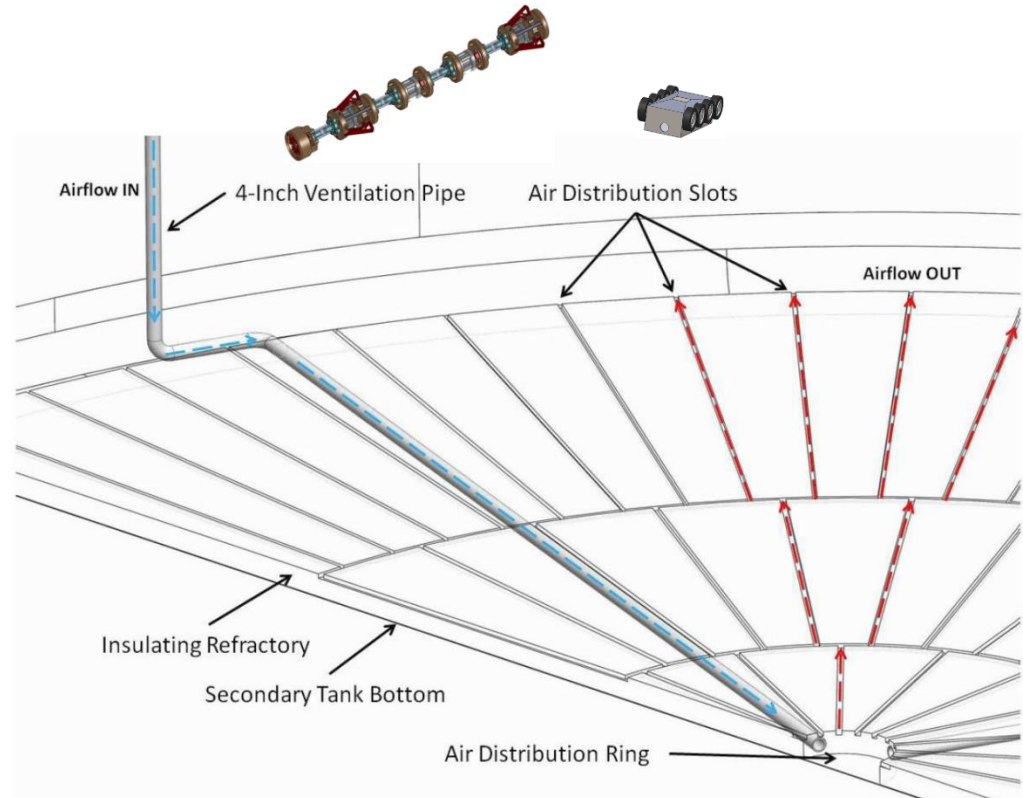



Task 18 - Technology Development and Instrumentation Evaluation



18.2 - Development of Inspection Tools for DST Primary Tanks

Objective:

Develop cost effective inspection tools that can travel through the refractory pad air channels underneath the primary liner and the drain line channels underneath the secondary liner while providing live video feedback.

Current Task:

Continue to develop our miniature rover to provide information regarding the health of the primary liners. This includes optimization of the design, development of a cable management system, sensor integration and demonstration on a full scale mockup.

Design Parameters:

Travel through small cooling channels, remote controlled, provide live video feedback, rad hardened (~ 80 rad/hr), withstand relatively high temperatures (~ 170°F), navigate ~ 50 feet to the tank center, maneuver through four turns, subject channel to pressures not greater than 200 psi.

Mini Rover

(Kayle Boomer, WRPS 2015)

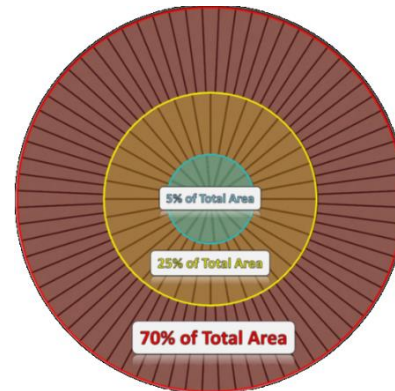

AY Tank Farm

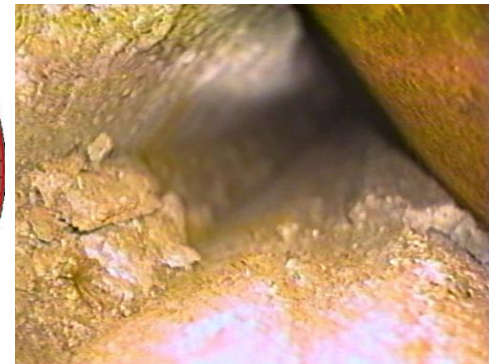

AZ/SY/AW/AN/AP Tank Farm

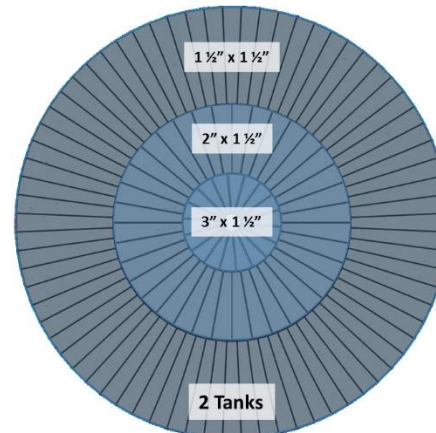

(Brandon J. Vazquez, WRPS 2015)

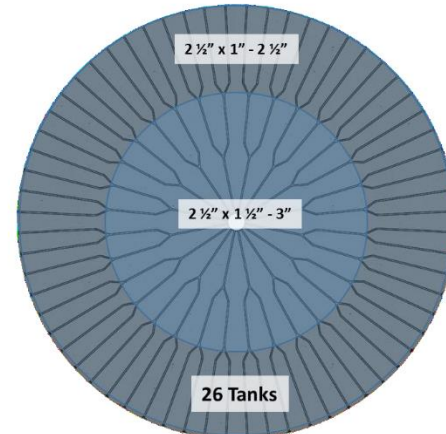

(Jason Gunter, WRPS 2015)



Task 18 - Technology Development and Instrumentation Evaluation

18.2 - Development of Inspection Tools for DST Primary Tanks



Traversing Weld Seams

Magnetic Arm Design

- Traverses up to $\frac{3}{8}$ th of an inch weld seam

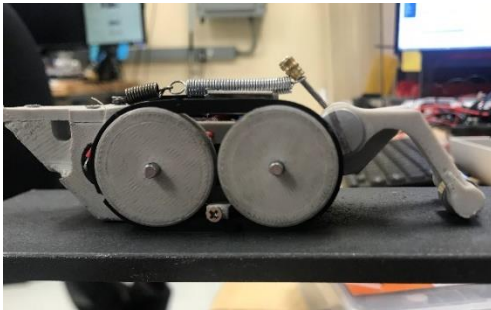
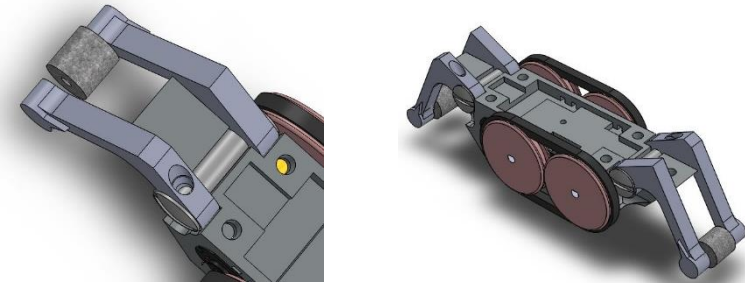



Task 18 - Technology Development and Instrumentation Evaluation

18.2 - Development of Inspection Tools for DST Primary Tanks



Traversing Weld Seams

Caterpillar Design

- Traverses up to one inch weld seam
- Initially designed for 90 degree turn

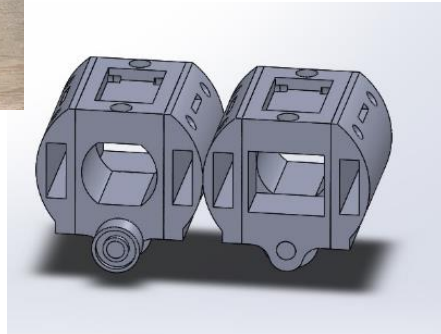
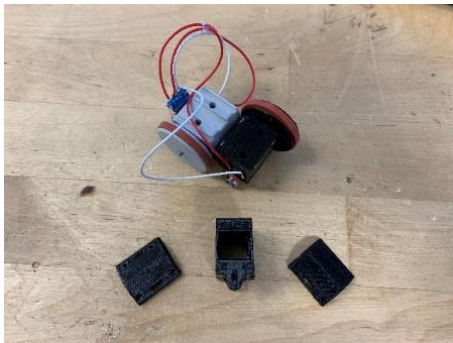



Task 18 - Technology Development and Instrumentation Evaluation

18.2 - Development of Inspection Tools for DST Primary Tanks



Controller Design

To address the problems of significant voltage drop and video signal transmission over long cable lengths, a control capsule was designed that will stay within the tank annulus.

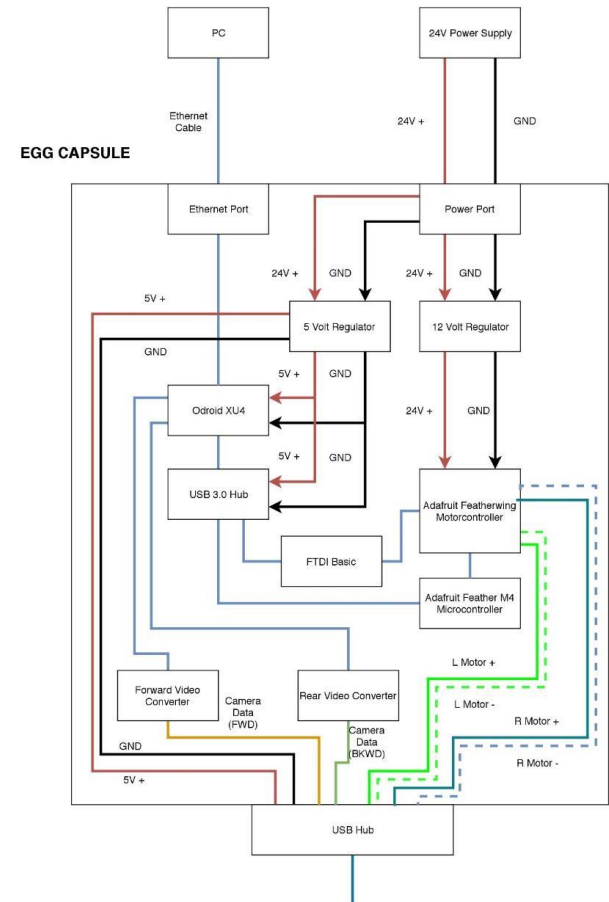
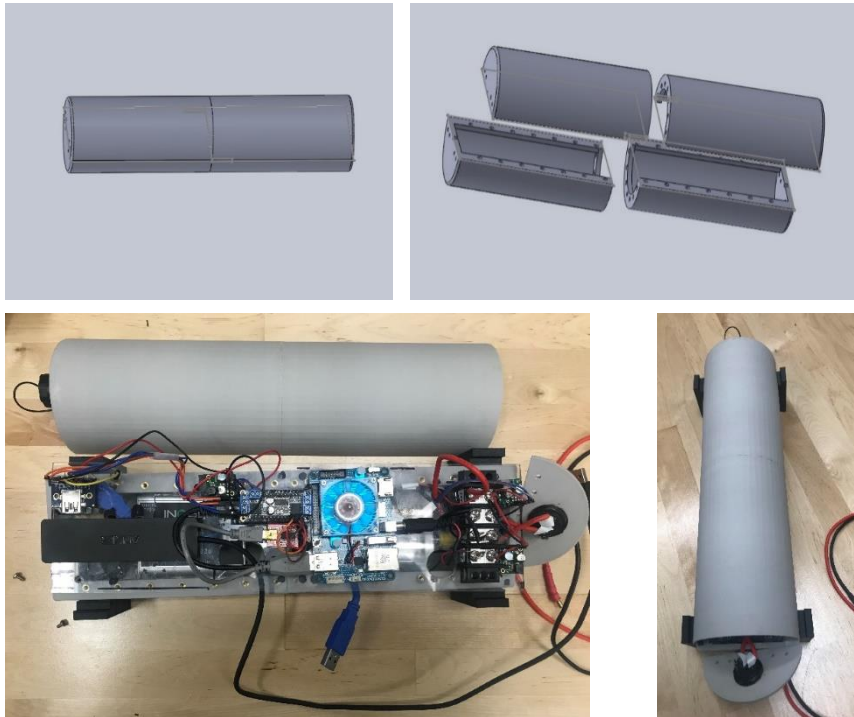



Task 18 - Technology Development and Instrumentation Evaluation

18.2 - Development of Inspection Tools for DST Primary Tanks



Electronic Boards

Current design:

- Rover sends and receives signals for controlling motor speed, video data, and sensor information in one cable bundle.
- Limited communication ports available between rover and controller.

New concept for future designs:

- Move electronics onto rover. Only information sent to rover will be communication data.
- Large number of input and output ports will be available.

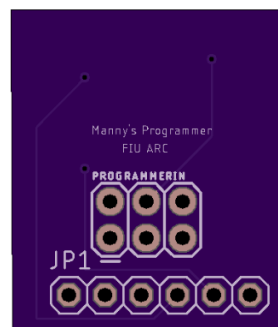
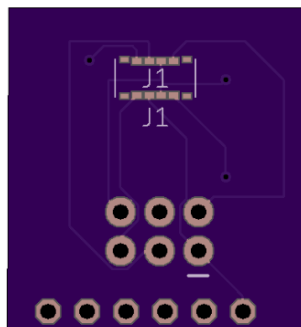
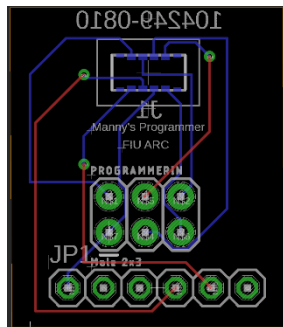
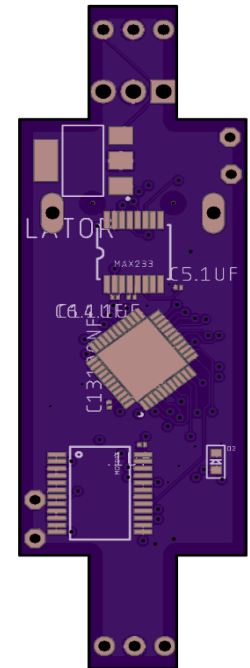
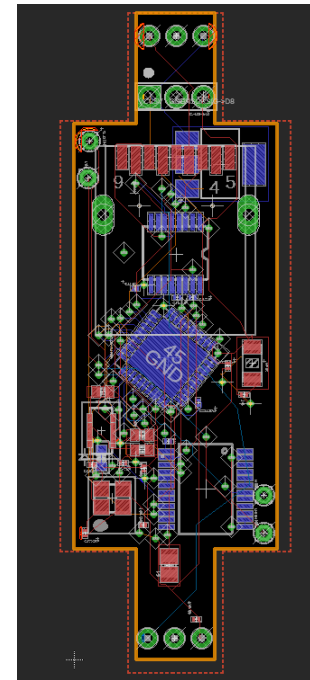



Task 18 - Technology Development and Instrumentation Evaluation

Considering multiple design concepts for integration of a UT sensor - a second module will house the UT sensor, deployment mechanism and surface preparation systems.

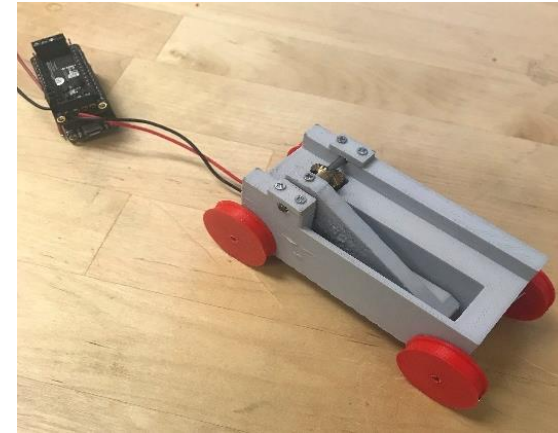

Signal Processing for Ultrasound Sensor

Time Of Flight Calculation

Ultrasound TX Pulser Evaluation Board

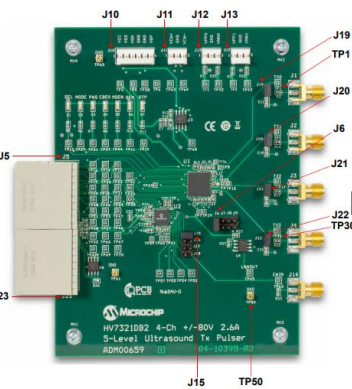

Microchip Ultrasound Platform Board (MUPB001)

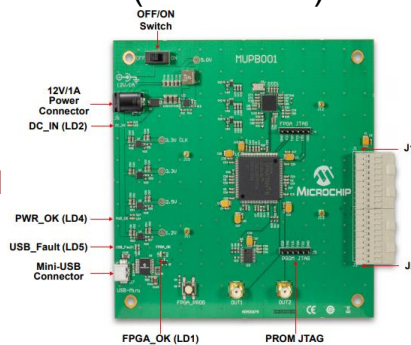

High frequency pulse generator

Test

UT sensor

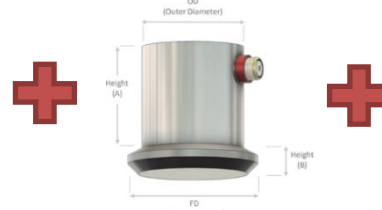

Implementation

Oscilloscope with minimum 500MHz BW and two high-impedance probes



High speed FPGA and TOF sensors





Task 18 - Technology Development and Instrumentation Evaluation

18.2 - Development of Inspection Tools for DST Primary Tanks



6-inch Crawler

Objectives:

Develop an inspection tool that navigates through the foundation drain slots under the secondary liners of the DST's at Hanford while providing live video feedback.

Current Efforts:

Development of a marsupial type crawler that can traverse through the 6 inch drain lines and deploy a rover into the drain slots.

The 6 inch crawler operates similar to the smaller crawler and will house rover/cable management system.

Finalizing module joint and the design of the rover deployment module.

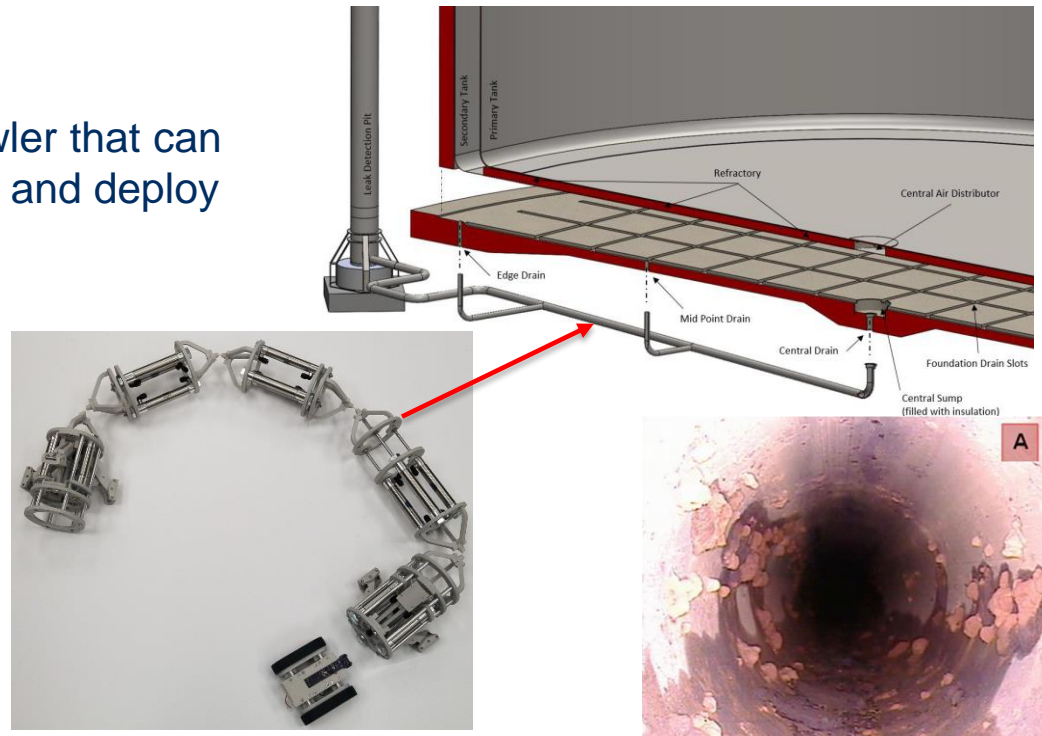



Task 18 - Technology Development and Instrumentation Evaluation

18.2 - Development of Inspection Tools for DST Primary Tanks

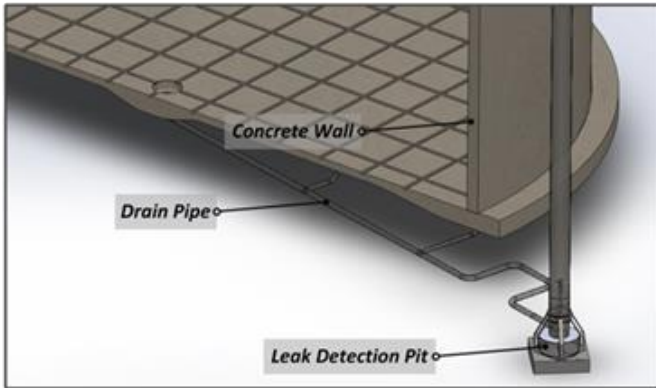

241-AZ, AZ, and SY Design

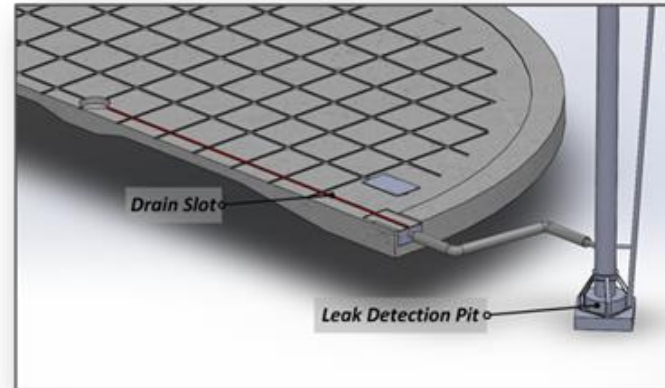

241-AW and 241-AN-107 Design

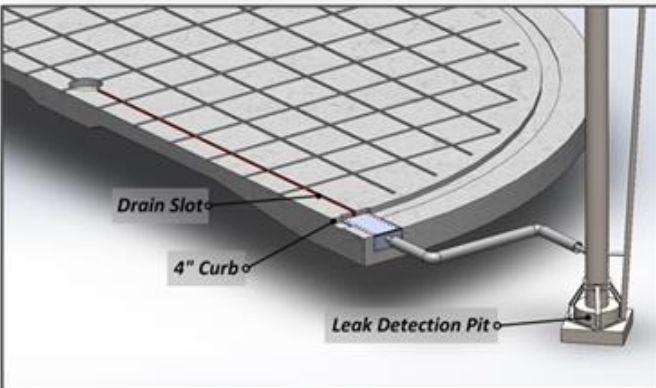
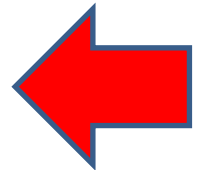

241-AN Design

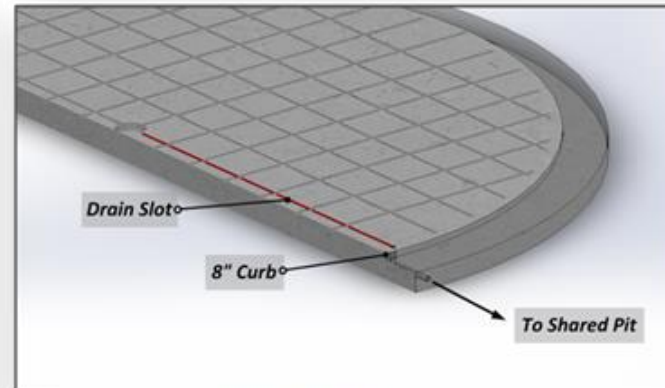

241-AP Design

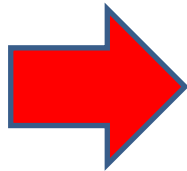



Task 18 - Technology Development and Instrumentation Evaluation

18.2 - Development of Inspection Tools for DST Primary Tanks

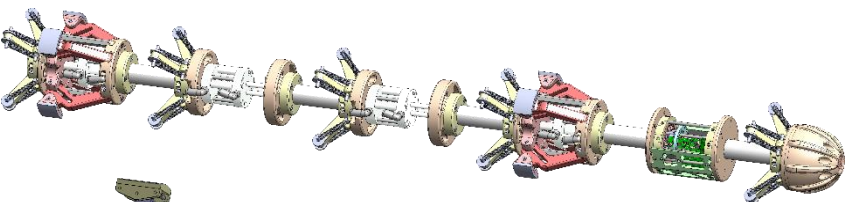

DST's Ventilation Header, and Transfer Lines

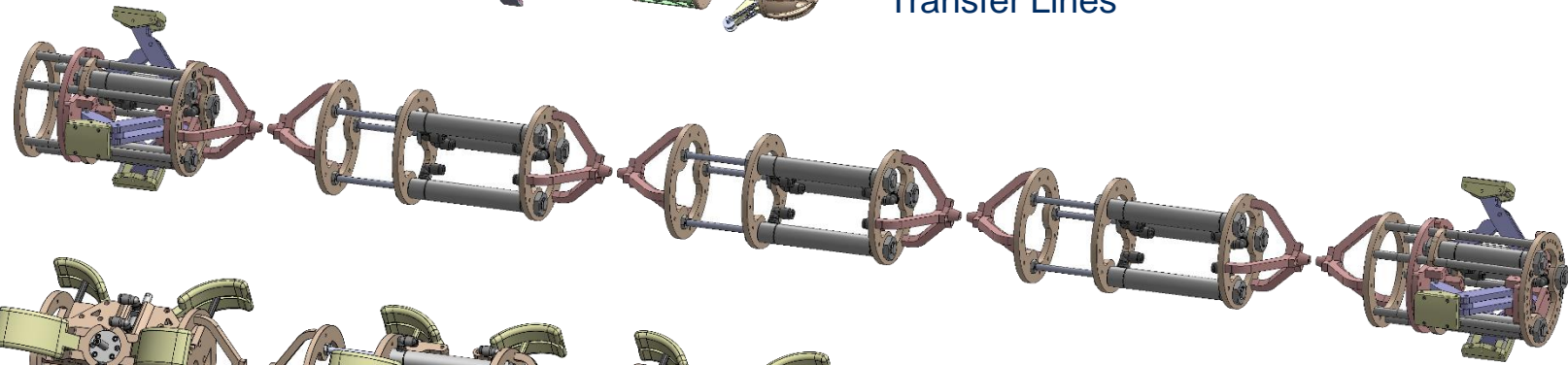

DST's Drain Line

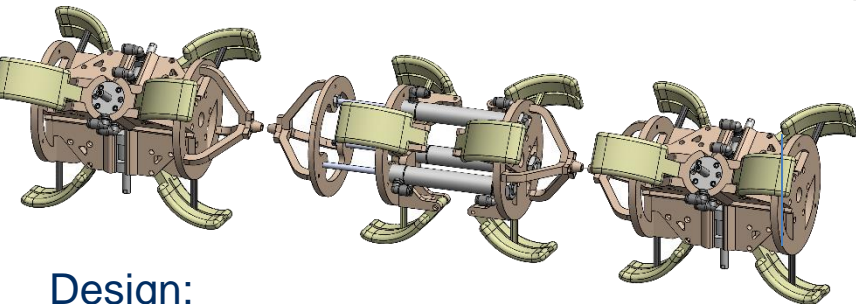

DST's Drain Slots

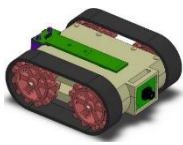

Design:

- Modular design
- Peristaltic locomotion
- Pneumatic actuation
- 3D printed parts

3"Ø & 4"Ø

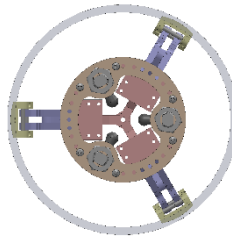
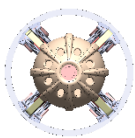

6"Ø

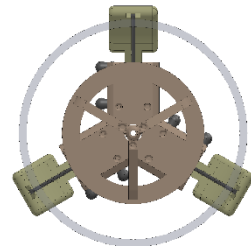



Task 18 - Technology Development and Instrumentation Evaluation

18.2 - Development of Inspection Tools for DST Primary Tanks

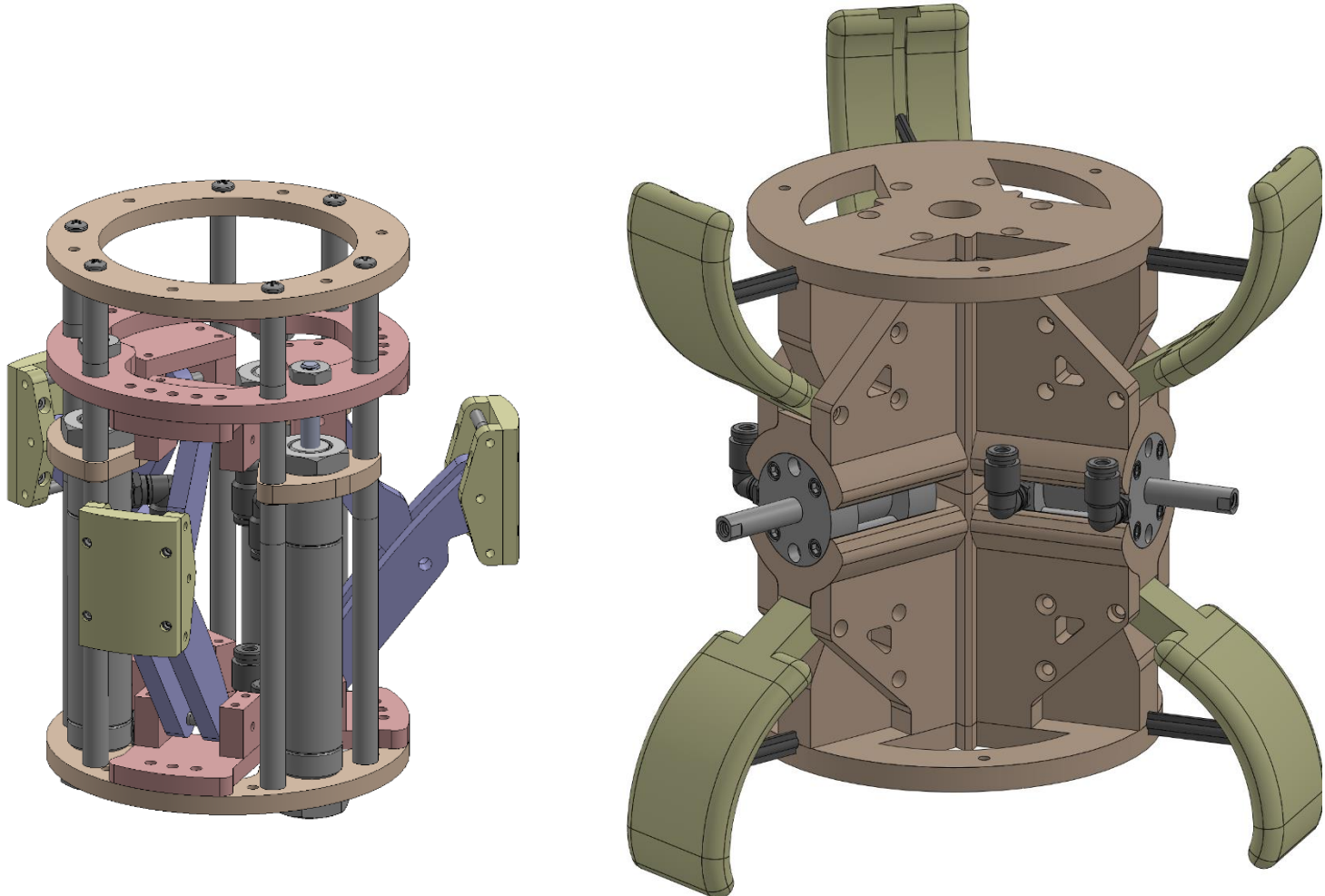



Task 18 - Technology Development and Instrumentation Evaluation

18.2 - Development of Inspection Tools for DST Primary Tanks



Design Challenges:

- Module buckling
- Sediment bulldozing

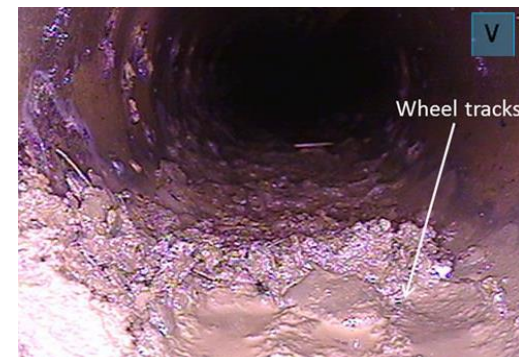
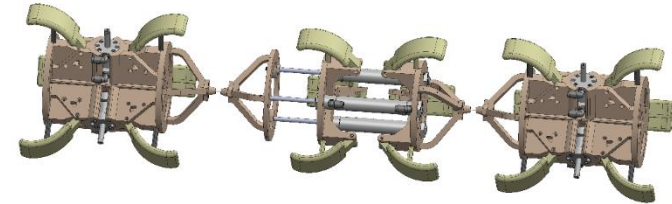
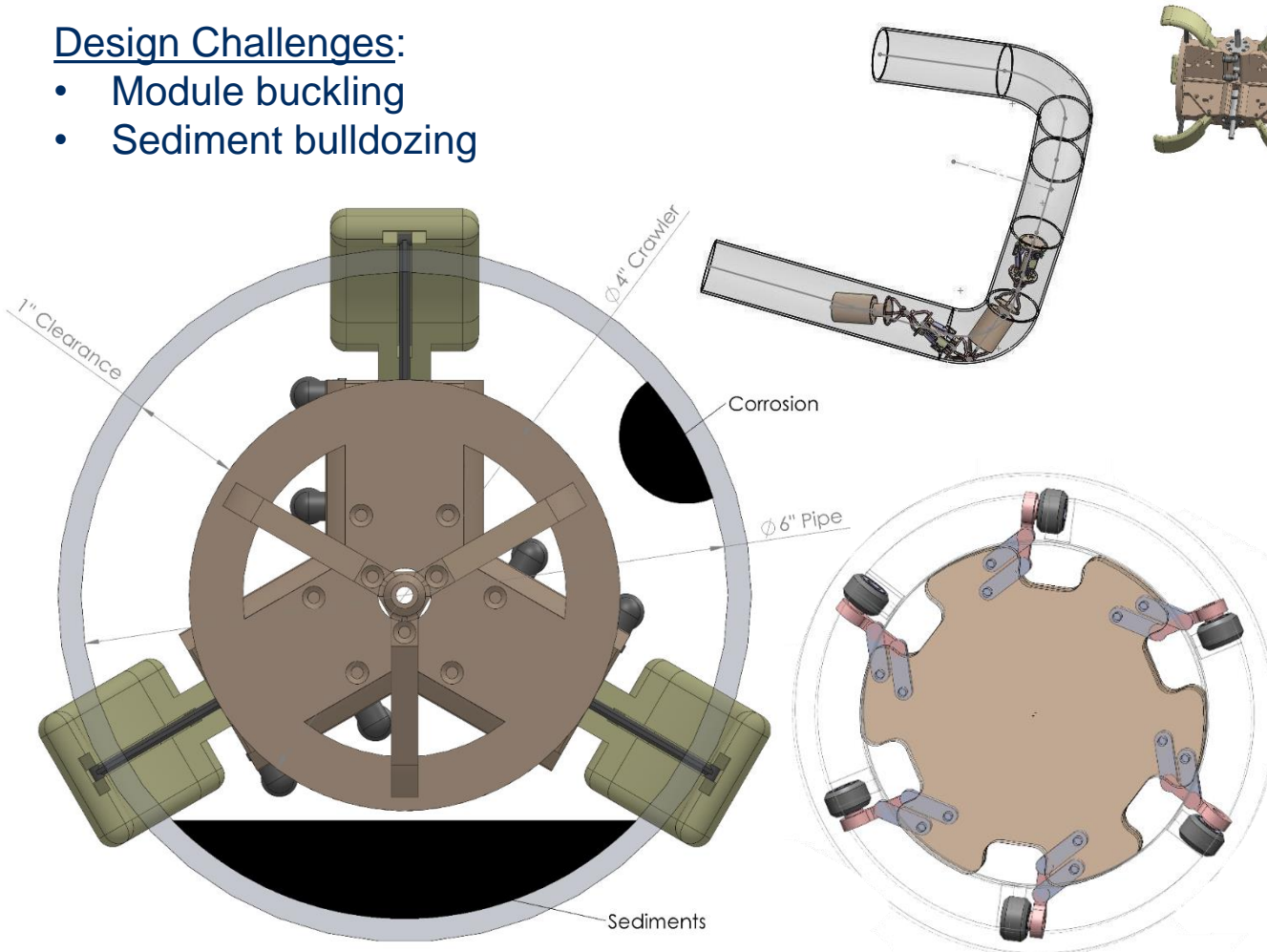



Task 18 - Technology Development and Instrumentation Evaluation

18.2 - Development of Inspection Tools for DST Primary Tanks

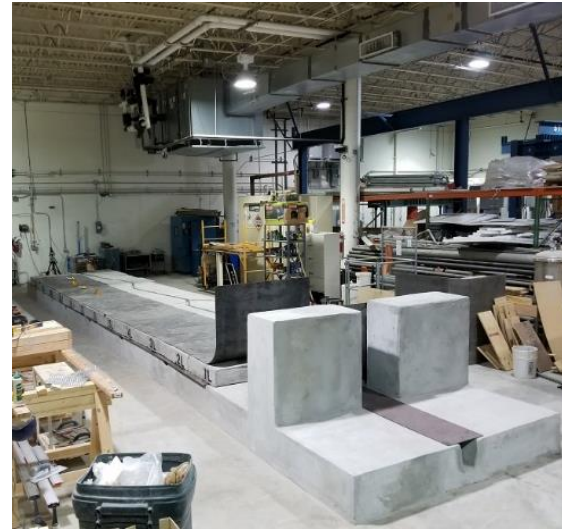
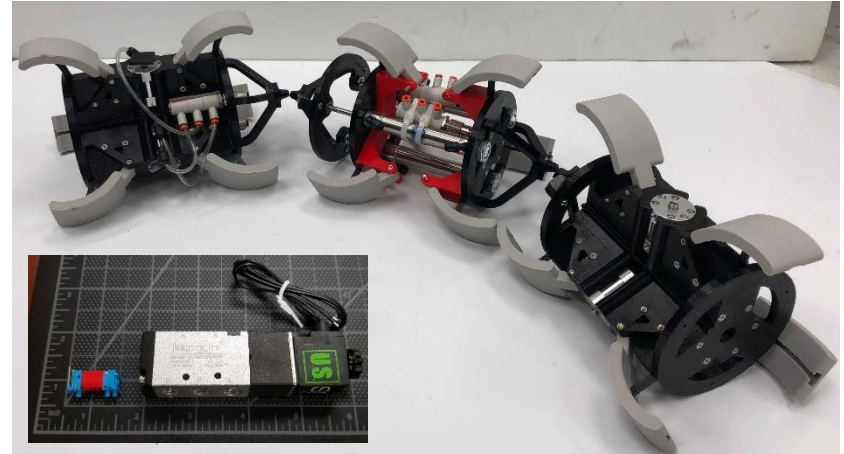
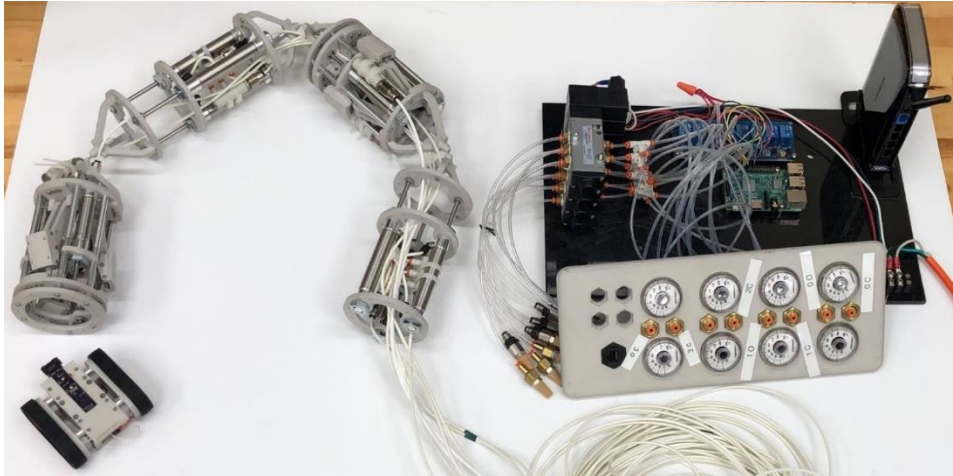



Task 18 - Technology Development and Instrumentation Evaluation



18.2 - Development of Inspection Tools for DST Primary Tanks

Sensor Module

Module was created to augment the functionality of the 3 and 4 inch crawler – provide additional information on the integrity of pipes.

Sensor	Measurement	Range	Resolution	Unit	Model
Environmental	Temperature	-40 – +85	±1	°C	BME280
	Pressure	30 – 110	±0.1	kPa	
	Humidity	0 – 100	0.008	%RH	
Inertial measurement unit (IMU)	Acceleration	±2, ±4, ±8, or ±16	±0.004	g	LSM6DS33
	Angular velocity	±125, ±245, ±500, ±1000, or ±2000	±10	°/s	
Radiation	Beta, gamma and X-rays	0.0001 – 100	±10%	mSv/h	RD2014
Camera	Surface imaging	640 x 480	VGA	Pixel	Generic
Light Detection and Ranging (LiDAR)	Circumferential mapping	10 – 100	±1	mm	VL6180X
Ultrasound	-	-	-	-	-

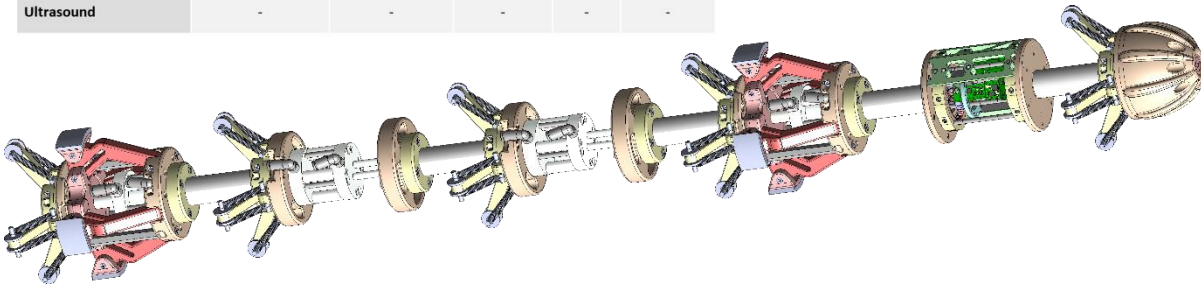
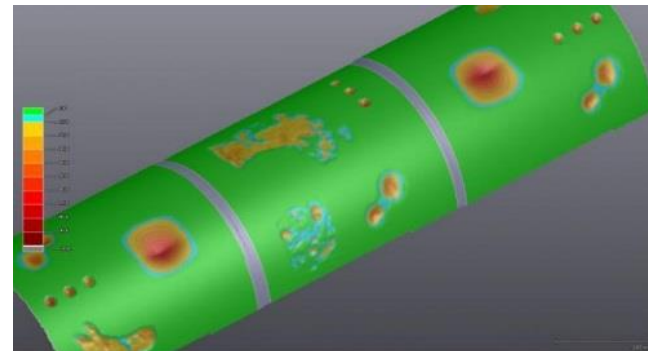
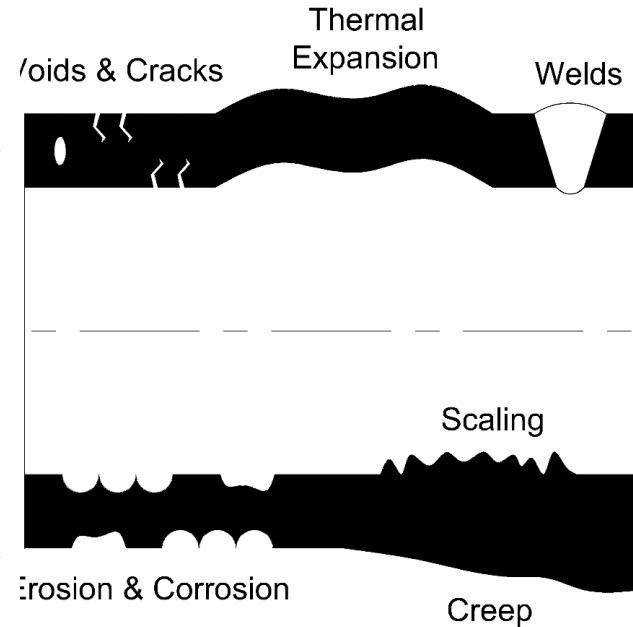
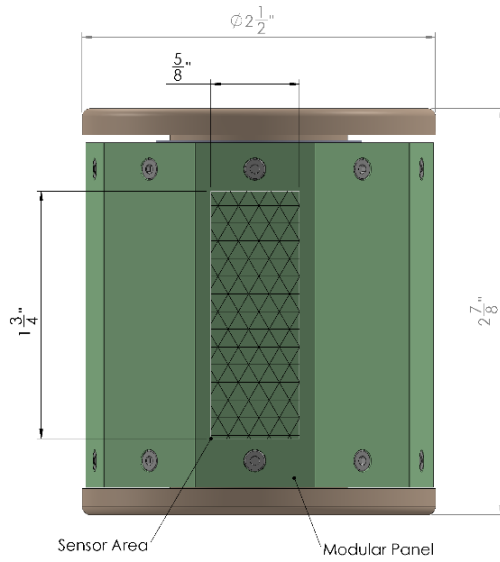



Task 18 - Technology Development and Instrumentation Evaluation

18.2 - Development of Inspection Tools for DST Primary Tanks

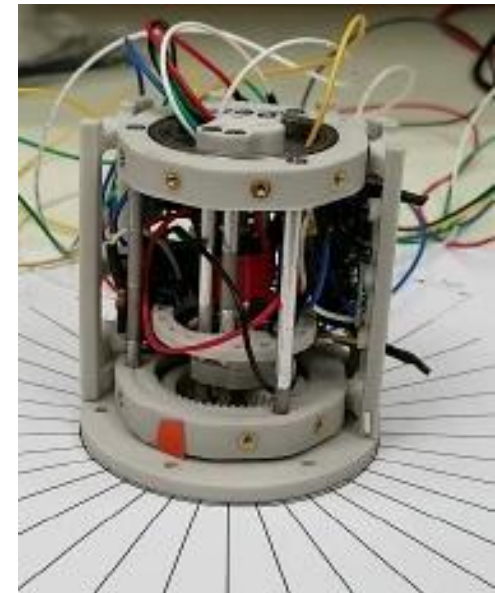
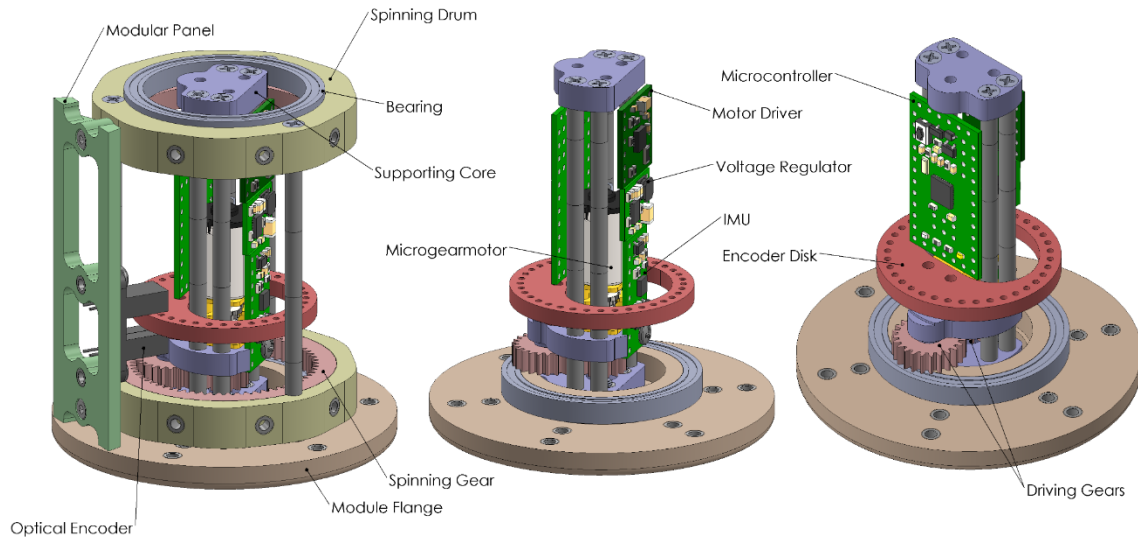



Task 18 - Technology Development and Instrumentation Evaluation

18.2 - Development of Inspection Tools for DST Primary Tanks

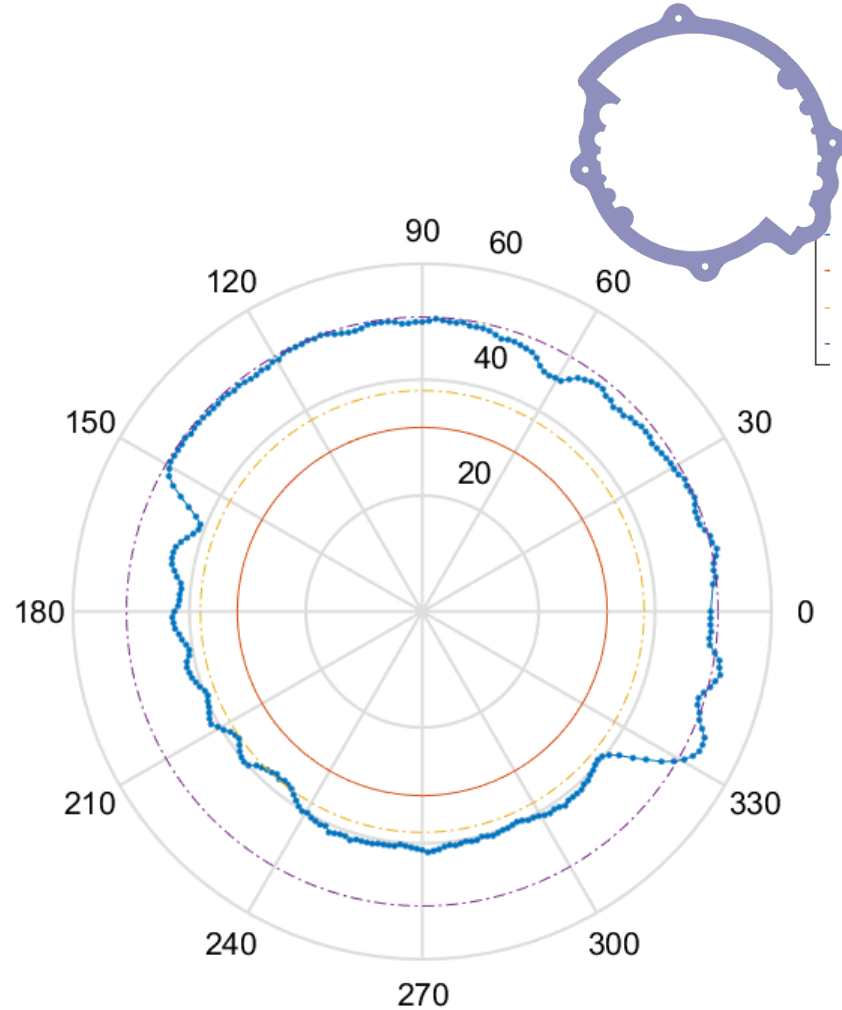
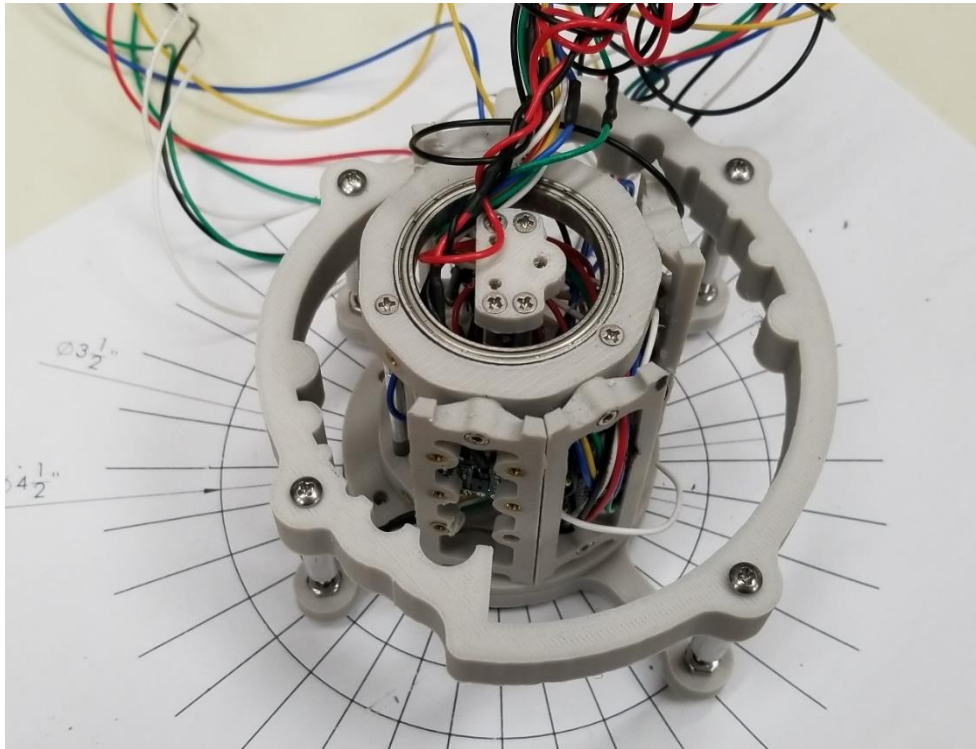



Task 18 - Technology Development and Instrumentation Evaluation

18.2 - Development of Inspection Tools for DST Primary Tanks



Proposed Scope for Performance Year 10

Crawler

- Complete the development of the inspection tool for the secondary liner that travels through the 6 inch leak detection line.
- Integrate miniature rover and validate in the full-scale mock-up at FIU.

Miniature Rover

- Deploy current system in hard to access slots at Hanford Tank Farm.
- Complete the design and the integration of the UT sensor module.
- Validate sensor system in full-scale mock-up.
- Continue the development of a system that can traverse around the corners in the refractory slots of A-101.



Task 18 - Technology Development and Instrumentation Evaluation



18.3 – Evaluation of coatings for the H-Canyon exhaust tunnel (New)

Site Needs:

Visual inspections of the H-Canyon exhaust (HCAEX) tunnel showed degradation of the concrete walls. Also, a recent tunnel fragility analysis identified safety issues of the affected concrete regarding their strength [1].

The identification and evaluation of repair materials to mitigate and prevent further degradation of the concrete walls is necessary.

Objectives:

- Literature review of 1) HCAEX tunnel, 2) concrete degradation mechanisms, and 3) repair options to mitigate and/or prevent degradation.
- Evaluate potential concrete repair materials for future deployment.



Tunnel view



Degraded concrete exposing the steel rebar (red arrows).¹

[1] Staff Report, Defense nuclear facilities safety board. H-Canyon exhaust tunnel fragility analysis input and assumptions. 2018.



Task 18 - Technology Development and Instrumentation Evaluation



18.3 – Evaluation of coatings for the H-Canyon exhaust tunnel (New)

Background and Literature Review

Tunnel visual inspections (1990-2017) confirmed:

- Steel rebar exposed (large areas)
- Loss of concrete cover (> 2 inches, large areas)
- Eroded surface (generalized)
- Water accumulation (some locations)
- Formation of concrete degradation compounds

Aggressive Environment

Tunnel environment

- Nitric acid fumes
- ~30 mph winds with debris
- 80-90% RH
- Radioactive materials
- 105°F temperature



Coarse aggregates and steel rebar exposed (arrows)



Accumulation of concrete products (e.g. CaCO₃)



Water accumulation





Task 18 - Technology Development and Instrumentation Evaluation



18.3 – Evaluation of coatings for the H-Canyon exhaust tunnel (New)

Literature Review – Concrete degradation mechanisms

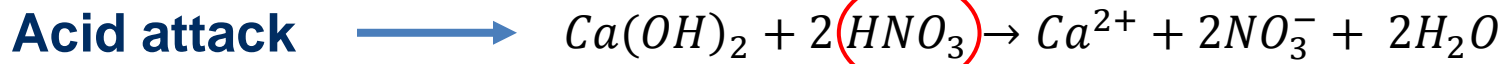

- Fast concrete disintegration (decalcification and pH reduction)
- Acid type (strong), concentration and time of exposure are crucial
- Loss of steel passivation (pH>9), corrosion

Erosion

- Increased by strong winds with debris and particles in suspension

Carbonation

- Acid attack due to carbon dioxide gas
- Less damage (carbonic acid: weak acid)

Electrochemical corrosion (steel)

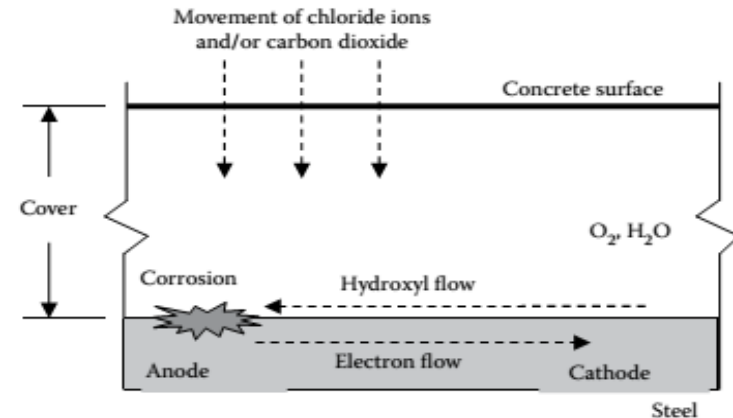

Corrosion process of steel rebar in concrete [1].

[1] Alexander, M. et al. Durability of Concrete. Design and Construction. CRC Press Taylor and Francis Group. 2017



Task 18 - Technology Development and Instrumentation Evaluation



18.3 – Evaluation of coatings for the H-Canyon exhaust tunnel (New)

Literature review - Potential repair materials for degraded concrete

Repair Materials	Resistance to				Application (Spray)	Availability	Ref.*
	Acids ^a	Water Permeability	High Temp.	Abrasion			
Coatings							
Epoxy	E, G	E, G	E ^c , G (40°C),	E	X	X	(15), (30)(31) (32)
Polyurethane	G (e.g. polyol-cured)	G, E	-	E (aliphatic urethane)	X	X ^b (1)	(15), (32),
Vinyls and latex-based materials	SB > WB coatings	-	-	-	X	X	(15)
Polyester and Vinyl ester materials	E	-	E ^c	-	Only manual	X	(15)
Silane, siloxane and siliconates	-	E	-	-	X	X	(15) (19),
Epoxy-siloxane (Hybrid Coating)	G	E	-	G	X	X	(22), (24)
Polyurea lining	E	-	-	E	X	X	(30)
Phosphate Ceramic Coatings	E (chemical resistant)	E	E ^c	E	X	X	(24)
Cristalline pore blockers	B	M	-	-	X	X	(14) (23),(30)
Overlays							
Styrene butadiene-modified cement mortar	M	M	M (40°C)		-	X ^b (2)	(31)
Epoxy-modified cement mortar	M	M	M (40°C)		-	X	(31)

*: See references in February 2019 monthly report.



Task 18 - Technology Development and Instrumentation Evaluation



18.3 – Evaluation of coatings for the H-Canyon exhaust tunnel (New)

Bench-scale testing - Concrete Aging (Stage 1)

1. Evaluation of concrete samples exposed to accelerated aging in simulated aggressive environments



2. Evaluation of selected concrete repair materials applied on aged concrete samples exposed to accelerated aging in simulated aggressive environments



3. Selection of potential repair materials from the testing findings



Samples preparation

- H-Canyon concrete mix received from Savannah river team
- Calculations done for preparing a preliminary small concrete batch
- Raw materials and tools ordered

Testing and Measurements

- Experimental design done
- Accelerated tests planned
- Aging chamber ready
- Equipment and materials ordered
- Measurements planned (durability, mechanical, visual, etc.)

In May, the FIU team presented to Savannah River Eng. team an overview of our proposal for the bench-scale testing (concrete aging phase) (under review).



Task 18 - Technology Development and Instrumentation Evaluation



18.3 – Evaluation of coatings for the H-Canyon exhaust tunnel (New)

Bench-scale testing (Concrete aging)

Experimental design

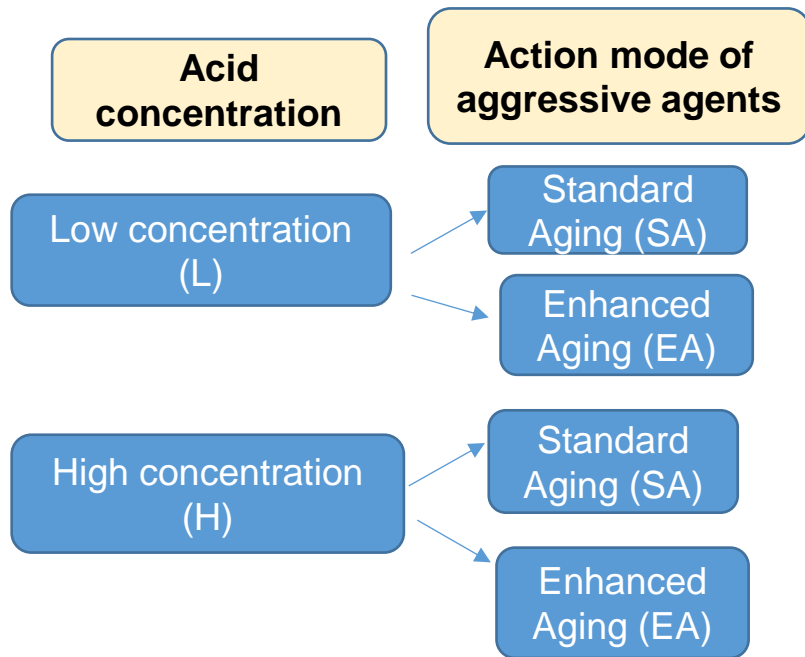

1- Port access for in-situ pH measurements or sample solution collection (pH measurement, calcium analysis, etc.).

2- Blue line indicates the level of nitric acid solution in the chamber.

3- Representative of concrete samples (e.g. cylinders or cylinder slices).

Aging chamber sketch

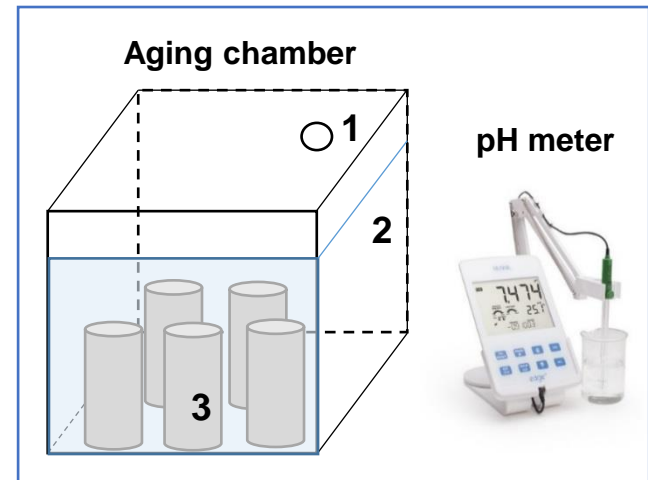

- Simulate worst conditions inside tunnel (immersion in acidic solutions)
- Measurements proposed (performance evaluation)
- Similar accelerated tests proposed (cyclic test)



Task 18 - Technology Development and Instrumentation Evaluation



18.3 – Evaluation of coatings for the H-Canyon exhaust tunnel (New)

Proposed Scope for Performance Year 10

- Complete initial bench-scale testing (stage 1) of the concrete samples including:
 - Evaluation of the aged concrete samples exposed to simulated aggressive environments.
 - Identification of key test parameters (acid concentration, exposure time, humidity, etc.) that may support the evaluation of repair materials (stage 2).
- Select potential repair materials for bench-scale testing (stage 2).
- Evaluate selected repair materials applied on aged concrete surfaces.
- Identify the best candidate repair materials from research findings.



Task 19 - Pipeline Integrity and Analysis

19.1 - Pipeline Corrosion and Erosion Evaluation



Site Needs:

Due to uncertainties regarding the structural integrity of pipelines at Hanford, a Fitness-for-Service (FFS) program for the Waste Transfer System has been implemented.

A direct inspection and assessment of the condition of buried pipelines is required to evaluate the corrosion and erosion wear rates. To predict the existing system's remaining useful life.

Objectives:

- Evaluate alternative approaches for real-time thickness measurements in pipes and waste transfer lines.
- Evaluating technologies that can be used to assess the integrity of pipelines.

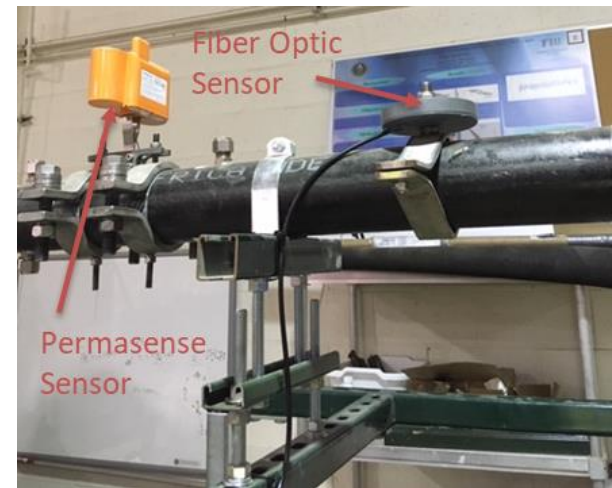

Thickness and Leak detection sensors



Task 19 - Pipeline Integrity and Analysis

19.1 - Pipeline Corrosion and Erosion Evaluation



Previous Efforts:

- Evaluation of Permasense Ultrasonic Sensor Systems
- Bench and Engineering Scale testing

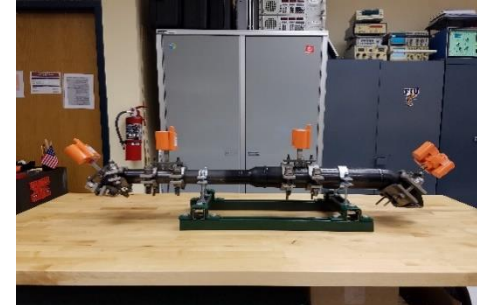

Bench scale testing

Erosion Test Loop:

- 4 Permasense guided wave sensors
- 2 and 3 inch pipe sections (straight sections and elbows)
- Sand/water mixture
- 3 HP centrifugal pump - up to 2.5m/s and 110 gpm
- Sand particle sizes - 400 to 1600 microns
- By-pass system to control flow rates



Engineering scale testing



Task 19 - Pipeline Integrity and Analysis

19.1 - Pipeline Corrosion and Erosion Evaluation

Results – Engineering Scale Testing

Erosion due to sand settling at the tank bottom

Pipe section	Initial Thickness (mm)	Thickness after one hour (mm)	Thickness After two hours (mm)	Thickness After three hours (mm)
2 inch straight	4.04	4.02	4.01	4.00
2 inch elbow	3.66	3.63	3.62	3.61
3 inch straight	5.43	5.43	5.43	5.43
3 inch elbow	5.75	5.75	5.75	5.75

Volume fraction changes

Test duration	Volume fraction (%)
Initial	20.0
1 hour	26.6
2 hours	31.3
3 hours	48.2

Samples collected at the tank exit

Sand particle size - 700 Microns

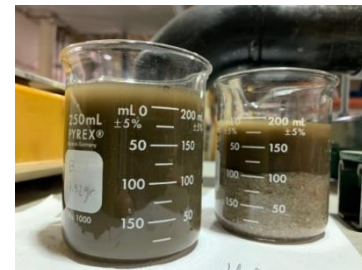



Task 19 - Pipeline Integrity and Analysis

19.1 - Pipeline Corrosion and Erosion Evaluation



Current Effort

Environmental Testing of UT Sensors

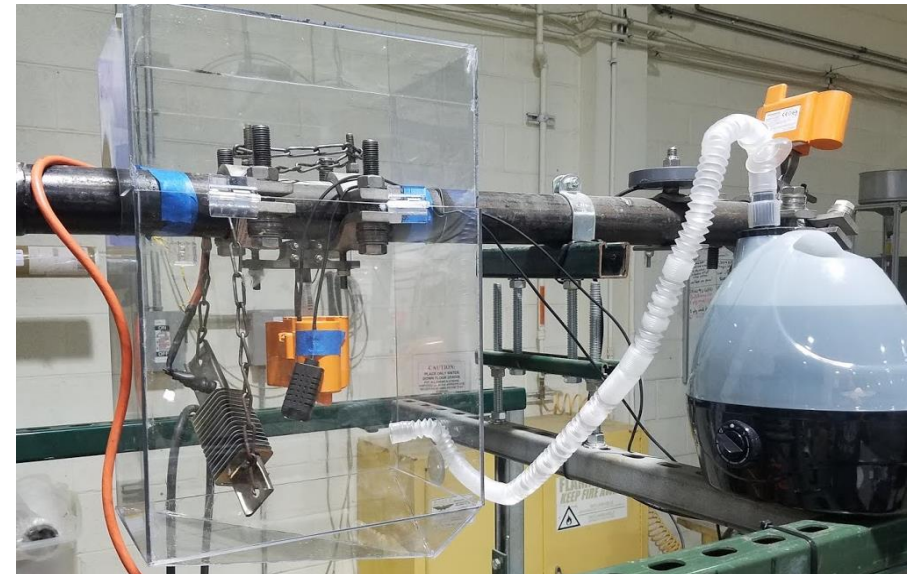
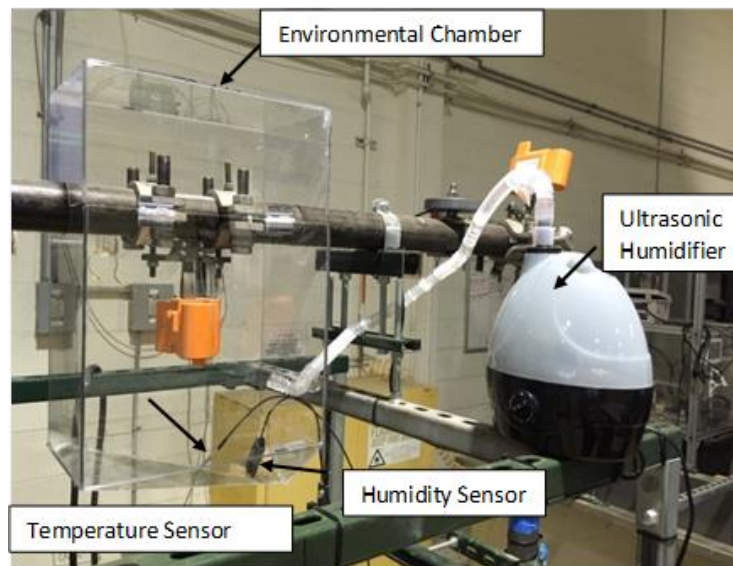

Temperature effect (range – 115°F to -25°F)

Humidity effect (range – 30% to 100%)



Task 19 - Pipeline Integrity and Analysis

19.1 - Pipeline Corrosion and Erosion Evaluation

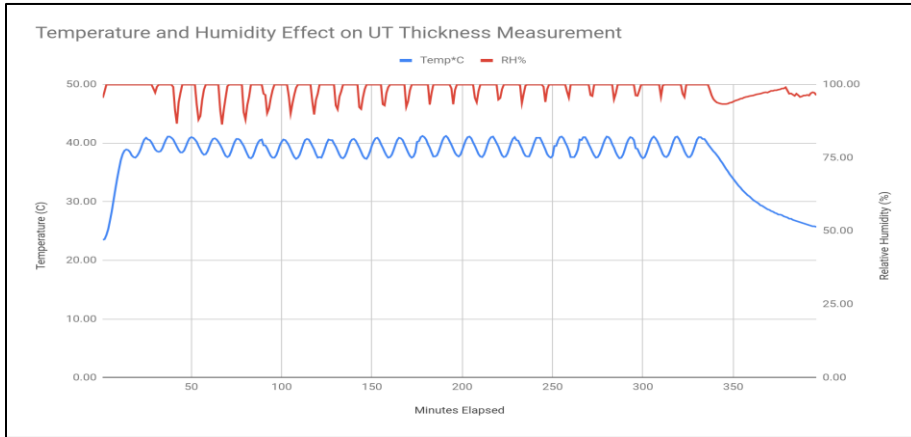

UT sensor Performance

Measurement	104F	122F	140F
30%RH	3.62mm	3.61mm	3.61mm
50%RH	3.62mm	3.61mm	3.61mm
70%RH	3.62mm	3.62mm	3.61mm

Constant temperature and humidity conditions

Dynamic temperature and humidity conditions

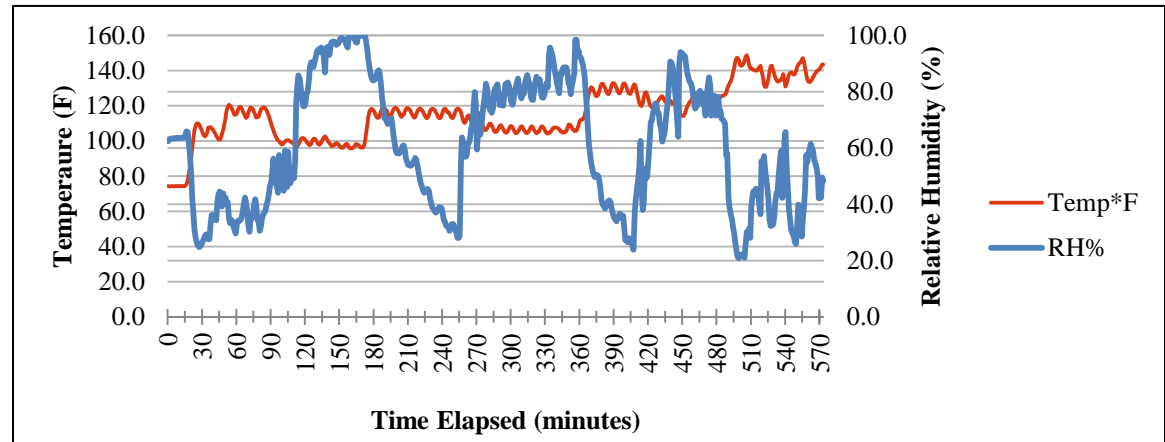



Task 19 - Pipeline Integrity and Analysis

19.1 - Pipeline Corrosion and Erosion Evaluation



Current Effort

SRNL Coupon Testing

- Incorporate additional method to measure sensitive wear rate
- Use UT sensors (pencil sensors) – thickness accuracy (0.0001in)
- Gravimetric measurements - mass loss ($\sim 0.00001\text{gm}$)
- Surface contour images for visual inspection of wear rate

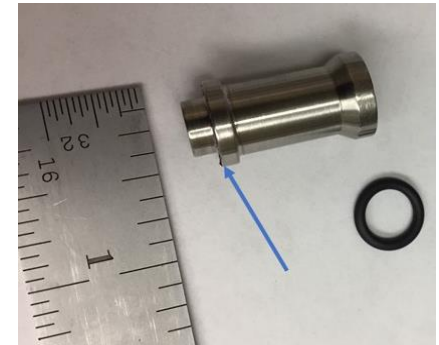

Erosion coupon

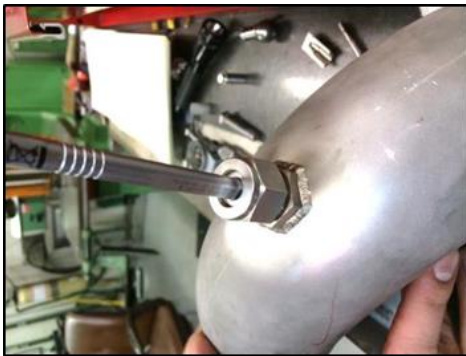

Coupon and UT sensor on an elbow



Coupons on the pipe loop



Task 19 - Pipeline Integrity and Analysis

19.1 - Pipeline Corrosion and Erosion Evaluation



SRNL Coupon Surface Images

Microscopic Images

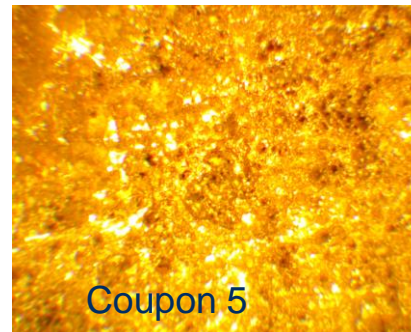
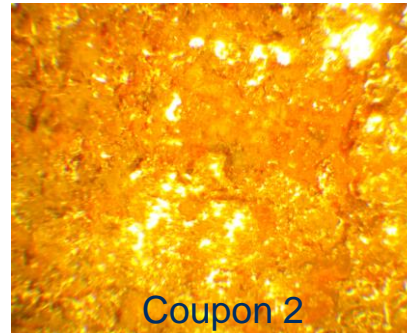
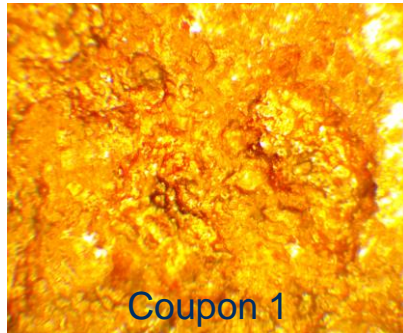
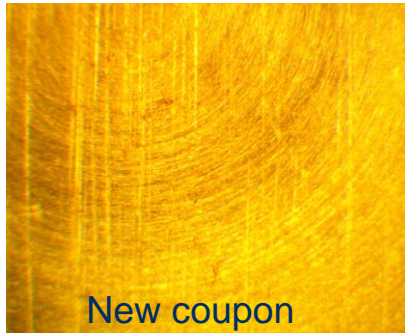

Endoscopic Images





Task 19 - Pipeline Integrity and Analysis

19.1 - Pipeline Corrosion and Erosion Evaluation



Current Effort

Leak/Crack Detection in Pipes

- Using Fiber Optic Sensors (Cleveland Electric Laboratories (CEL))
- Deploy a combination of fiber optic and electroacoustic technologies to accurately identify the location of a pipeline leak or crack.



Fiber optic sensors

installed on the pipe loop

- 4 Sensors
- Diameter – 4in
- Thickness – 0.75 in

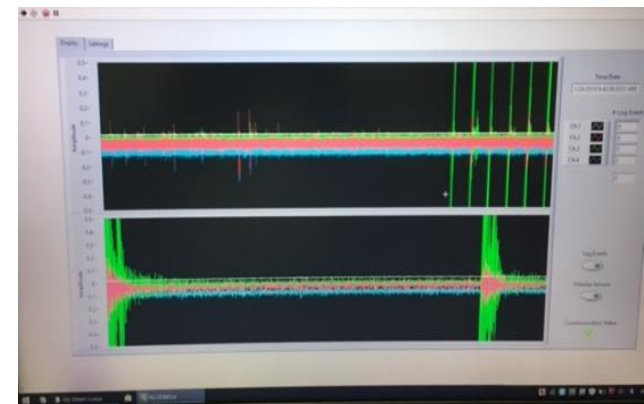

Sample results



Task 19 - Pipeline Integrity and Analysis

19.1 - Pipeline Corrosion and Erosion Evaluation



Proposed Scope for Performance Year 10

- Investigate the option of conducting radiation testing on the Permasense UT systems with Hanford and SRNL teams.
- Complete the evaluation of Permasense UT sensors under extreme environmental conditions and monitor real-time changes in pipe thicknesses.
- Evaluate CEL fiber optic sensor systems for leak detection in pipes
- Continue testing the SRNL mass loss coupons during the sand slurry erosion tests.
- Conduct material tests on eroded pipe sections and SRNL coupons.



Task 19 - Pipeline Integrity and Analysis

19.2 - Evaluation of Nonmetallic Components in the Waste Transfer System

Site Needs:

Nonmetallic materials are used in the US DOE's Hanford Site Tank Farm waste transfer system. These include inner primary hoses in the HIHTLs, Garlock[®] gaskets, EPDM O-rings, and other nonmetallic materials.

Nonmetallic materials are exposed to β and γ irradiation, caustic solutions as well as high temperatures and pressure stressors. How they react to each of these stressors individually has been well established, but simultaneous exposure of these stressors is of great concern.

Objectives:

- Provide the Hanford Site with data obtained from experimental testing of the hose-in-hose transfer lines, Garlock[®] gaskets, EPDM O-rings, and other nonmetallic components under simultaneous stressor exposures.
- Due to experimental testing location limitations, no radiation exposure testing will be conducted.



Task 19 - Pipeline Integrity and Analysis

19.2 - Evaluation of Nonmetallic Components in the Waste Transfer System

Previous work:

- Recent studies have involved aging of nonmetallic materials in a NaOH solution.
- Material tested included:
 - Hose-in-hose transfer line (HIHTL) inner hose
 - EPDM and Garlock® dog-bone coupons
- Each material sample was “aged” by exposure to a 25% sodium hydroxide solution at 100°F, 130°F and 170°F for a durations of 180 and 365 days.
- After aging, the mechanical/material properties of the samples measured and compared to unaged samples to identify any degradation in the properties.
- Hose burst pressure as well as material tensile strength test were conducted.



Current work:

- Evaluate hose and material dog-bone samples using a scanning electron microscope with energy dispersive X-ray spectroscopy (SEM-EDX) to determine if there is a correlation between sodium penetration and burst pressure strength.
- In order to determine the effect of the NaOH on the material degradation, experiments were repeated with only water at 170°F



SEM – EDX Results Dog Bones

6-Month Results

Baseline

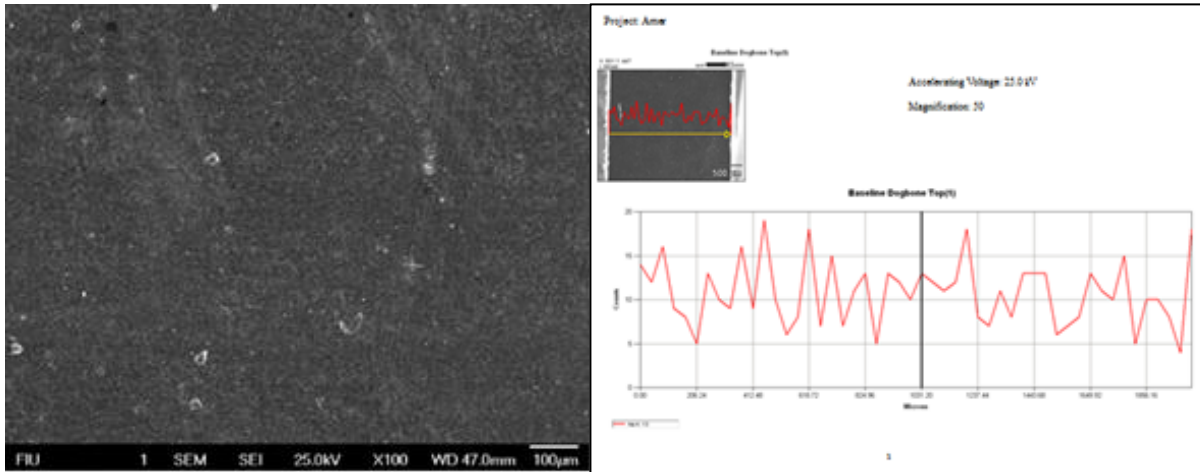

170°F

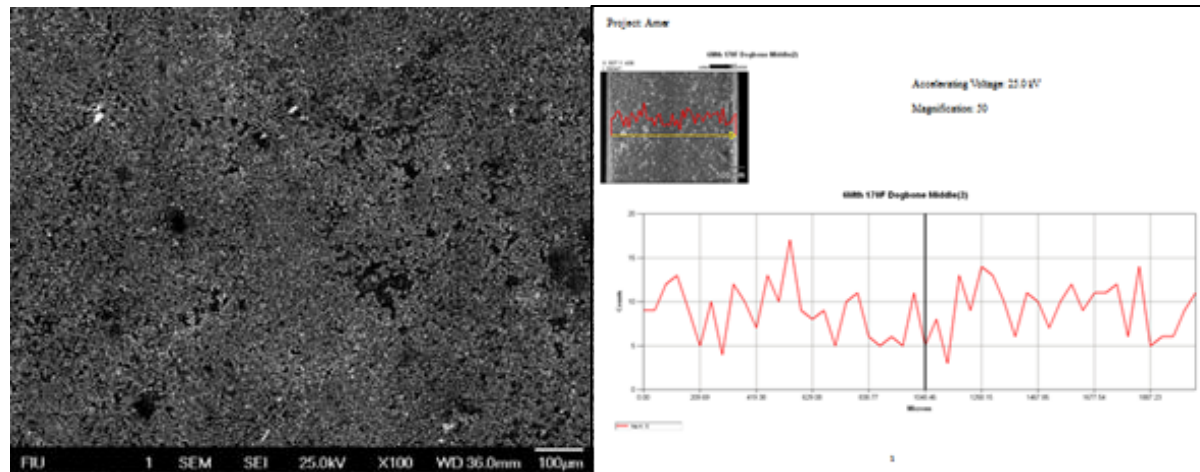



SEM – EDX Results Dog Bones

12-Month Results

Baseline

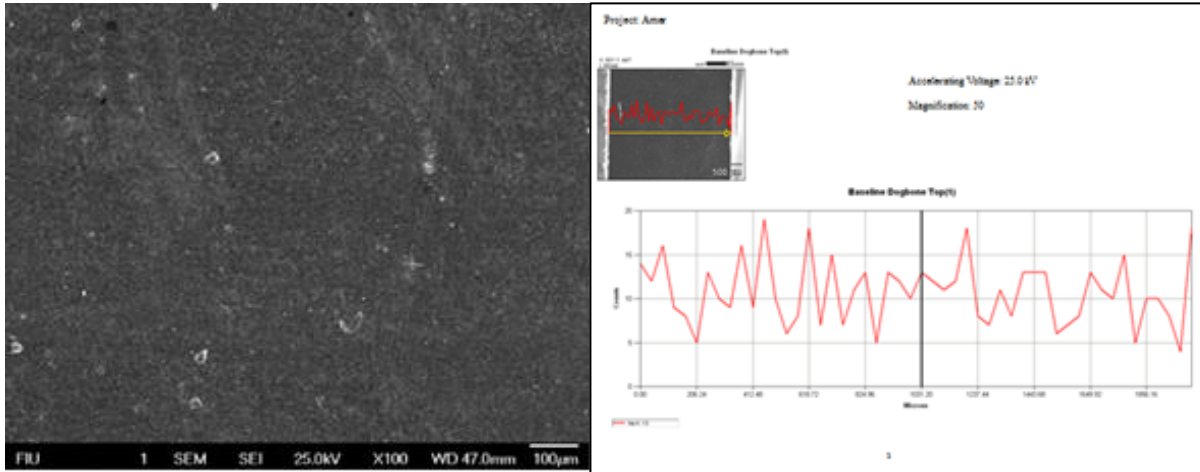

170°F

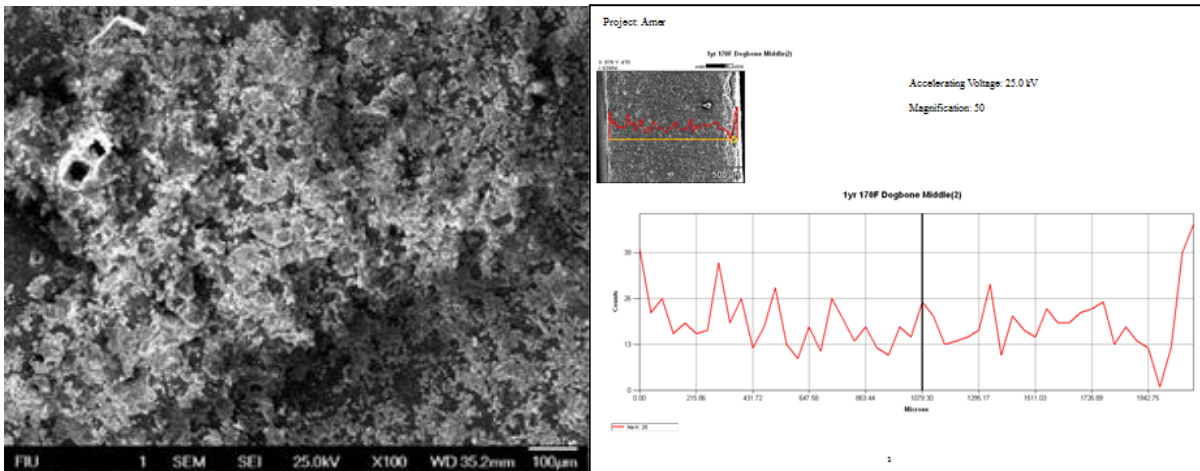



SEM – EDX Results Hose Section



6-Month Results

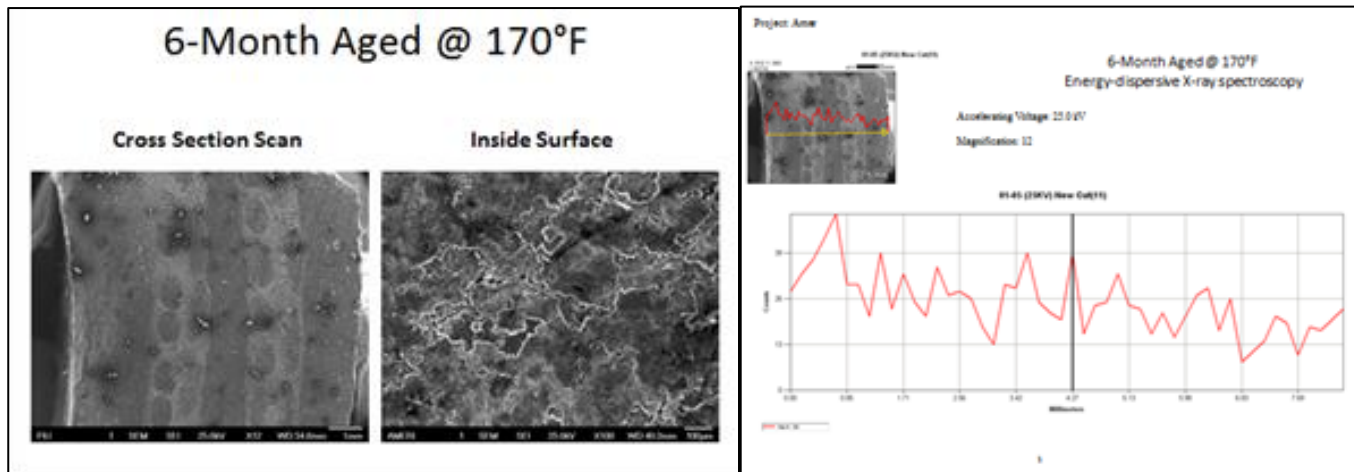
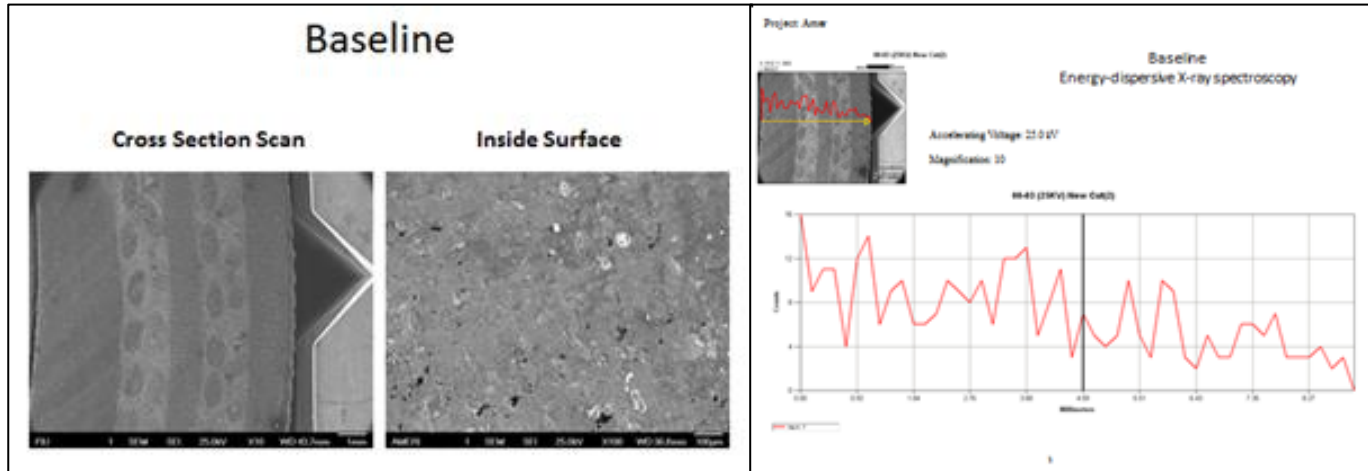



SEM – EDX Results Hose Section



12-Month Results

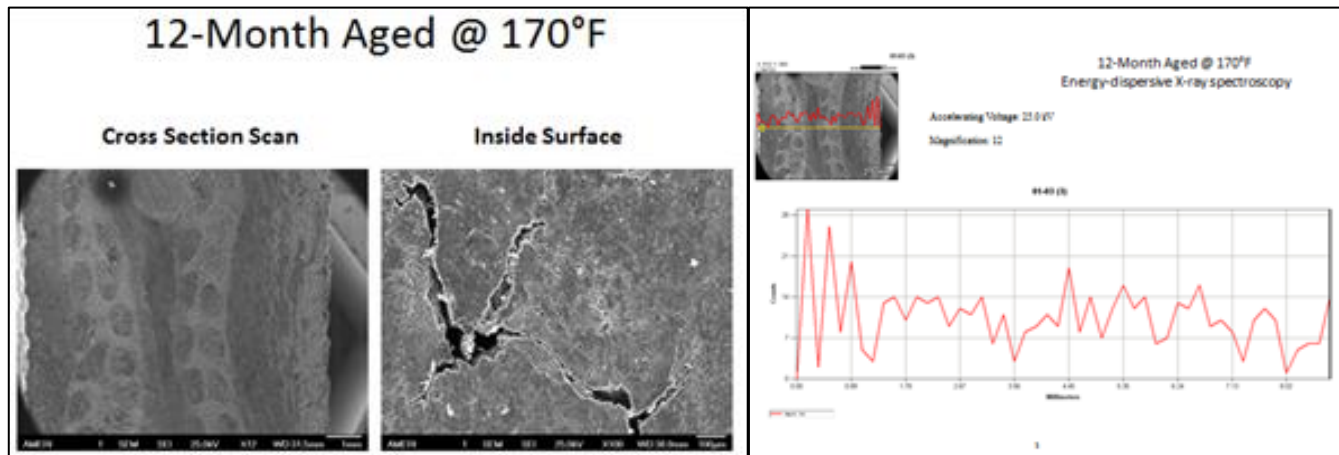
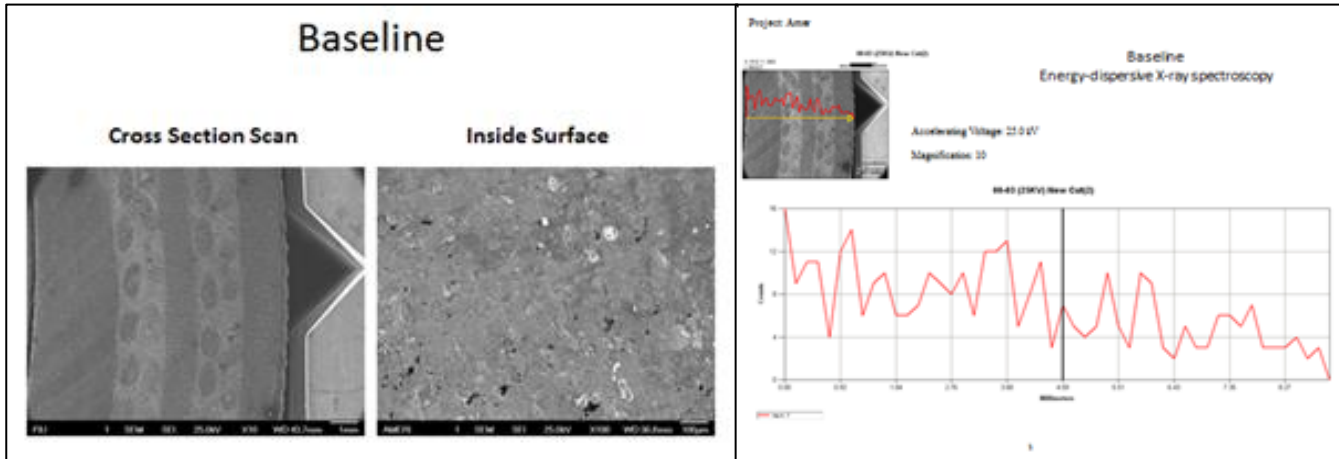



Water Only Aging Loop

- In order to determine the effect of the NaOH on the material degradation, the experiments were repeated with only water.
- The setup consisted of a pumping loop with two hose sections. Water at 170°F was circulated through the loop.
- The coupon aging consisted of a coupon aging vessel submerged in the test loop's storage tank.
- Each vessel contained three EPDM and three Garlock® Dog bone samples.





Pressure Test Results

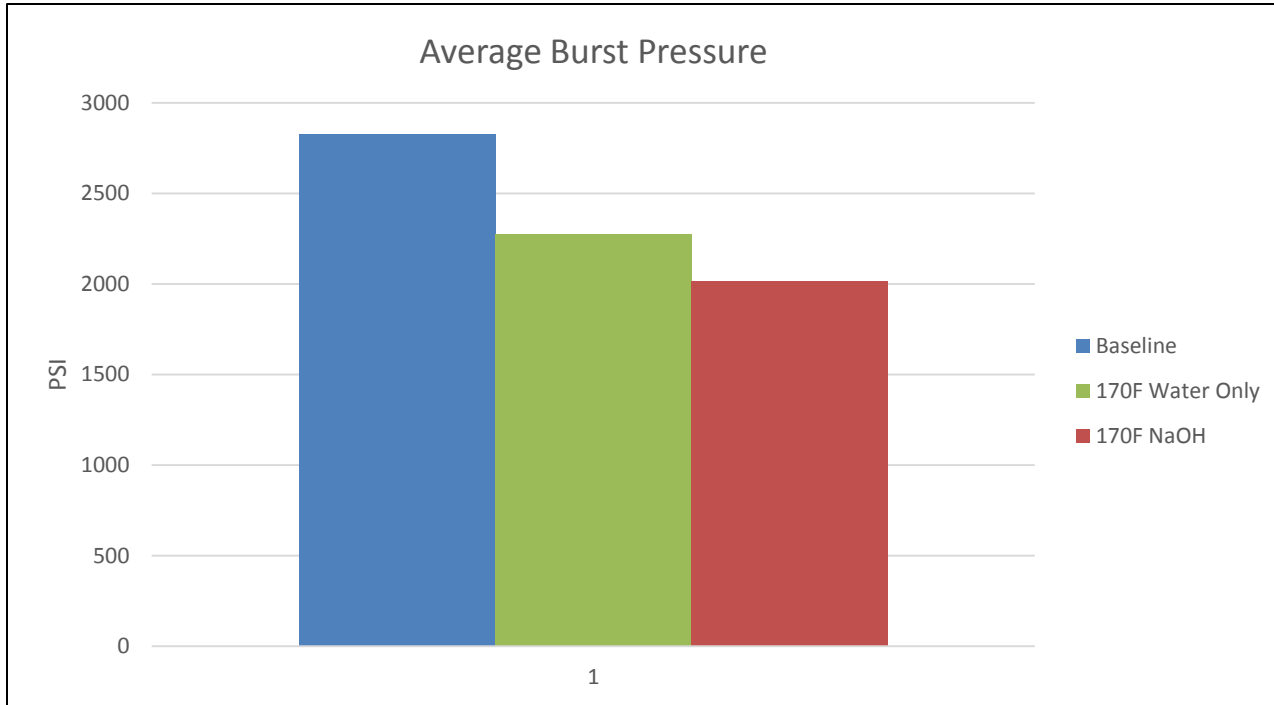



Task 19 - Pipeline Integrity and Analysis

19.2 - Evaluation of Nonmetallic Components in the Waste Transfer System

Proposed Scope for Performance Year 10

- Complete SEM-EDX on both the HIHTL coupons and the material coupons.
- After discussing the water only test results with the site personnel, investigate obtaining additional HIHTL coupons to perform additional testing in consultation with site personnel.



Task 20 – Support for Technology Evaluation Using DST Mockup



Proposed Scope for Performance Year 10

- Provide access to DOE-EM and its contractors to use FIU's DST sectional mockup to evaluate the viability of inspection tools, robotic systems and sensors.
- Provide support for the testing and evaluation.
- Work with engineers to make modifications to the mockup, as needed.